

# TECHNICAL BOOK

Armadi, Cabine /  
Wardrobes, Walk-in closet

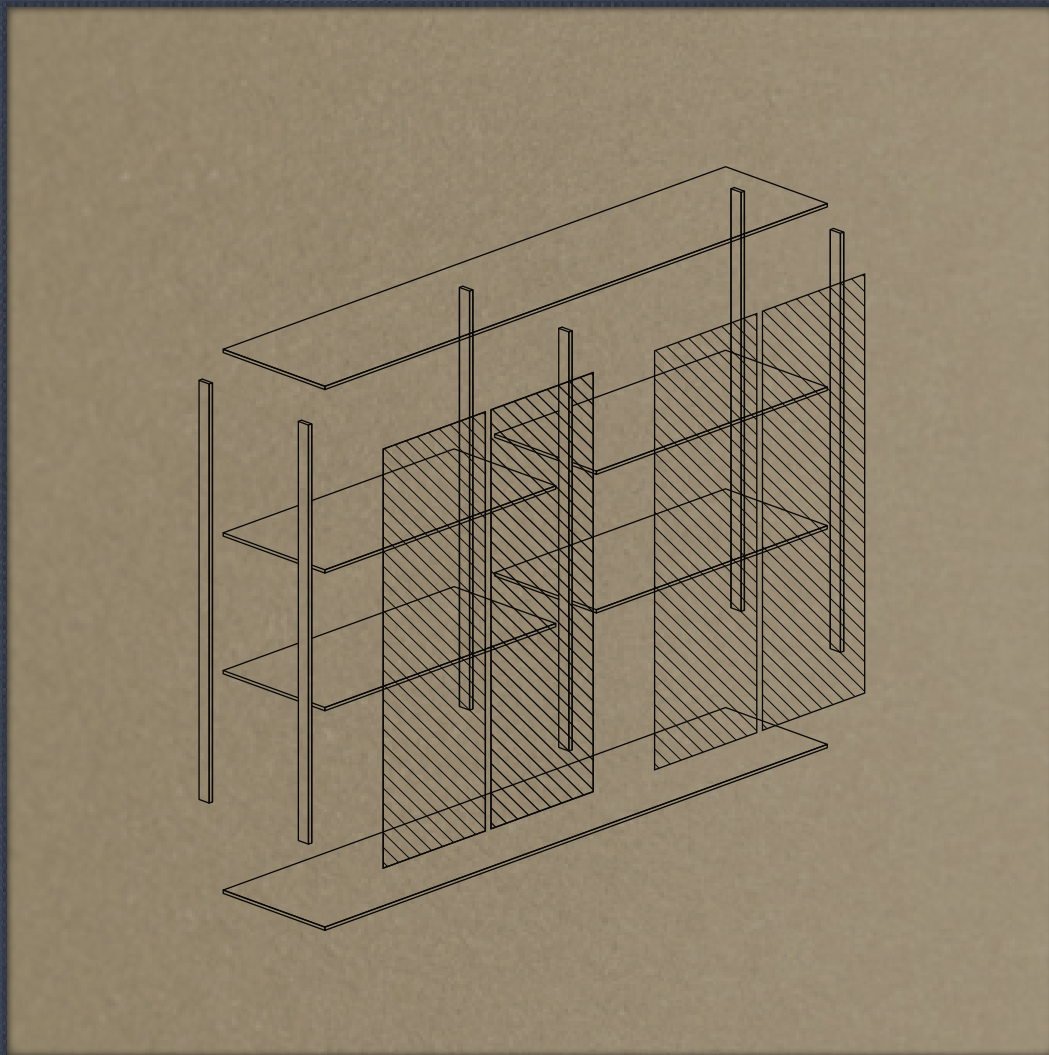

**PIANCA**

## TECHNICAL BOOK

Armadi, Cabine /  
Wardrobes, Walk-in closet

**PIANCA**

## Indice / Index

Introduzione / Introduction	4	Cabine e complementi /	
Armadi / Wardrobes	6	Walk-in closets and complements	126
Amalfi	8	Anteprima	128
Cornice	16	Sipario	140
Crea	24	Teatro	152
Icona	32	Teatro con anta Murano /	
Manhattan	40	Teatro with Murano door	164
Milano	48	Vista	172
Murano	56	Island <sub>up</sub>	180
Nastro	64	Info tecniche / Technical info	188
Plana	72		
Raggio	88		
Tratto	96		
Verona	104		
Anta TV / TV Door	112		
Home Office	118		

<sup>IT</sup> Qualità, funzionalità, versatilità. Personalizzabili con un'ampia scelta di finiture, complementi e accessori, gli armadi e le cabine Pianca nascono nel nome della massima libertà progettuale. Grazie a dettagli ricercati e lavorazioni su misura oltrepassano i confini della zona notte per organizzare qualunque ambiente - living, cucina, spazi di servizio. Finiture, ante, tipologia di apertura e moduli speciali possono essere scelti e combinati tra loro per realizzare la soluzione perfetta per le proprie esigenze. Sartoriale, fino al più piccolo dettaglio.

<sup>EN</sup> Quality, functionality and versatility. Customisable with a wide choice of finishes, furnishings and accessories, Pianca wardrobes and walk-in closets are created to celebrate maximum design freedom. Thanks to their refined detailing and made to measure solutions, they go beyond the boundaries of the bedroom area to organise any room in the home including the living room, kitchen and utility rooms. Finishes, doors, types of opening and special modules can be chosen and combined to create the perfect solution for your needs. Tailor-made, right down to the smallest detail.

# Armadi / Wardrobes



Amalfi p.8



Cornice p.16



Crea p.24



Icona p.32



Manhattan p.40



Milano p.48



Murano p.56



Nastro p.64



Plana p.72



Raggio p.88



Tratto p.96



Verona p.104



Anta TV / TV Door p.112



Home Office p.118



IT Un'estetica ricercata che rifugge il superfluo, lasciando spazio a superfici ampie e continue. Maniglie a tutta altezza, in tinta o a contrasto con l'anta, enfatizzano le geometrie lineari e i profili delicati, sposandosi con le diverse aperture disponibili: battente, scorrevole, complanare e cardine che, grazie alle caratterizzanti cerniere, permette l'apertura delle ante a 180°. Molteplici le possibilità di personalizzazione capaci di rivestire l'armadio di rinnovati significati e funzioni, come quelle offerte dal modulo home office e dall'anta TV.

EN A refined aesthetic that avoids the superfluous, making room for large, flowing surfaces. Full-height handles, matching or contrasting the door finish, emphasise the linear structures and delicate outlines, blending with the different openings available. These include hinged, sliding, flush sliding and cardine hinged which, thanks to the characteristic hinges, allows the doors to open 180°. There are many customisation options to give the wardrobe renewed meaning and functions, such as those offered by the home office module and the TV door.



Amalfi armadio con apertura cardine. Ante Frassino Lino, maniglia e cerniere Canna di Fucile. Interni materico Perlage Conchiglia. / Amalfi wardrobe with Frassino Lino cardine hinged doors, Canna di Fucile handle and hinges. Perlage Conchiglia materico interior.





1 – Amalfi armadio con apertura battente. Struttura e ante Canaletto, Maniglia Champagne opaco. / Amalfi hinged door wardrobe. Canaletto doors and sides, matt Champagne handle



2 – Amalfi armadio cardine. Ante e fianchi laccato opaco Avio, maniglia e cerniere Canna di Fucile. / Amalfi cardine hinged door wardrobe. Avio matt lacquered doors and sides, Canna di Fucile handle and hinges.



3 – Amalfi armadio scorrevole. Ante e fianchi Borgogna, maniglia Champagne opaco. / Amalfi sliding door wardrobe. Borgogna doors and sides, matt Champagne handle.



4 – Amalfi armadio complanare. Ante laccato lucido Seta, fianchi laccato opaco Seta, maniglia Champagne opaco. / Amalfi flush sliding door wardrobe. Seta high gloss lacquered doors, Seta matt lacquered sides, matt Champagne handle.



IT Il tratto sottile e continuo del telaio disegna un profilo discreto ed essenziale. In alluminio Laccato Opaco o Anodizzato Nero, ritma la successione di elementi verticali, oppure tende a mimetizzarsi se coordinato alla superficie delle ante, disponibili in vetro, specchio, essenza, materico, pelle sintetica e laccate. Longilinea e leggermente angolata, la maniglia nasce come naturale continuazione del telaio, garantendo un'immagine elegante e lineare, e un'ottima prensilità per ogni tipologia di anta, a battente, scorrevole o complanare.

EN The slim, uninterrupted line of the frame draws a discreet and minimal outline. In Matt Lacquered or Black Anodized aluminium, it punctuates the run of vertical modules or tends to blend in when coordinated with the surface finish of the doors available in glass, mirror, wood and materico finishes as well as synthetic leather and matt or gloss lacquers. Long and slightly angled, the handle is designed to form a line that carries on from the frame, giving the door an elegant, linear appeal and offering an excellent grip to any type of hinged, sliding and flush sliding door.



Cornice armadio con apertura battente e terminali con apertura scrigno. Ante in pelle sintetica Cactus, Maniglia e telaio in Alluminio Anodizzato Nero. Interni materico Larice Tortora, frontali cassetto con inserto in pelle sintetica Cactus. / Cornice hinged door wardrobe and terminal module with L-shaped opening. Cactus synthetic leather doors, handle and frame in Black Anodized Aluminium. Larice Tortora materico interior, drawer fronts with Cactus synthetic leather insert.



1 — Cornice armadio battente. Ante vetro marmo Amani opaco, fianchi laccato opaco Fango. Maniglia e telaio in Alluminio Anodizzato Nero. / Cornice hinged door wardrobe. Matt Amani marble glass doors, Fango matt lacquered sides. Handle and frame in Black Anodized Aluminium.



2 — Cornice armadio scorrevole. Struttura e ante Frassino Castano. Maniglia e telaio in Alluminio Anodizzato Nero. / Cornice sliding door wardrobe. Frassino Castano doors and sides. Handle and frame in Black Anodized Aluminium.



3 — Cornice armadio complanare. Ante vetro Metallizzato Bronzo, fianchi laccato opaco Fango. Maniglia e telaio in Alluminio Anodizzato Nero. / Cornice flush sliding door wardrobe. Metallizzato Bronzo glass doors, Fango matt lacquered sides. Handle and frame in Black Anodized Aluminium.



IT Design ricercato dallo stile raffinato ed eccentrico. Il motivo geometrico delle ante crea un ritmo di superfici vetrate lucide ed opache: rettangoli di varie dimensioni e proporzioni che si alternano e si accostano trovando radici in un linguaggio artistico moderno. Di grande impatto grafico è la maniglia, che si configura come un taglio orizzontale che rafforza la bellezza della composizione. Può essere laccata opaca o in essenza ed è ricavata all'interno delle ante, disponibili scorrevoli o complanari.

EN A refined design with a stylish, glamorous appeal. The geometric door pattern offers a juxtaposition of glossy and matt glass surfaces. Rectangles in different dimension blend and merge, stemming from a modern artistic language. The handle has a strong graphic impact, cutting across the doors in a horizontal line that enhances the beauty of the composition. Available matt lacquered or in wood, it is recessed inside the panel of sliding or flush sliding doors.



Crea armadio con apertura complanare. Ante in vetro laccato opaco e lucido Seta. Maniglia laccato opaco Seta. interni Perlage Terra con ripiani Duna laccato opaco Seta. / Crea wardrobe with Seta glossy and matt lacquered flush sliding glass doors. Seta matt lacquered handle. Perlage Terra materico interior with Seta Duna matt lacquered shelves.





1 — Crea armadio scorrevole. Ante vetro laccato opaco Roccia, fianchi laccato opaco Roccia, maniglia Borgogna. / Crea sliding door wardrobe. Roccia matt lacquered glass doors, Roccia matt lacquered sides, Borgogna handle.



2 — Crea armadio complanare. Ante vetro laccato opaco e lucido Piombo, fianchi laccato opaco Pimbo, maniglia Frassino Antracite. / Crea flush sliding door wardrobe. Piombo glossy and matt lacquered glass doors, Pimbo matt lacquered sides, Frassino Antracite handle.





IT Design lineare e versatile dai dettagli sofisticati. Icona si veste di personalità attraverso il connubio tra sobrietà ed espressività. Incassata nel pannello in legno, la maniglia rappresenta un elemento distintivo e raffinato, da personalizzare in base al proprio gusto: con colori laccati vivaci o più neutri, con finiture metalliche classiche o più eccentriche, nella versione opaca o lucida. Laccate, in essenza o materico, le ante hanno apertura a battente, scorrevole o complanare.

EN A linear, versatile design sporting sophisticated details. Icona conveys its personality by pairing understated beauty with expressiveness. The handle – recessed into the wood panel – is a distinctive, refined accent that can be customised to suit individual tastes: choose from bright or more neutral lacquer colours, with classic or more sophisticated metallic finishes, in glossy or matt version. Lacquered, in wood or with a textured finish, the doors come in the hinged, sliding and flush sliding versions.



Icona armadio con apertura scorrevole. Ante e fianchi di finitura laccato lucido Bosco. Maniglia Titanio opaco. Interni Perlage Terra. / Icona wardrobe with Bosco high gloss lacquered sliding doors. Bosco high gloss lacquered finished sides. Matt Titanio handle. Perlage Terra materico interior.



1 — Icona armadio battente. Ante e fianchi materico Larice Tortora, maniglia laccato opaco Fango. / Icona hinged door wardrobe. Larice Tortora materico doors and sides, Fango matt lacquered handle.



2 — Icona armadio scorrevole. Ante e fianchi laccato opaco Ecrù, maniglia Titanio opaco. / Icona sliding door wardrobe. Ecrù matt lacquered doors and sides, matt Titanio handle.



3 — Icona armadio complanare. Ante e fianchi Frassino Antracite, maniglia Titanio lucido. / Icona flush sliding door wardrobe. Frassino Antracite doors and sides, glossy Titanio handle.



IT Design fresco e moderno, ispirato ad un'estetica minimale dalle linee contemporanee. La sofisticata geometria della maniglia ricorda un affusolato profilo alare, costituita da un taglio verticale lungo l'anta e da una parte interna personalizzabile nelle finiture laccate, nelle essenze e nelle finiture metallo opaco o lucido. Ancora più vasta la possibilità di scelta per le ante, disponibili in vetro, specchio, essenza e laccate, da coordinare o meno con la maniglia, per un effetto tono su tono oppure in contrasto.

EN A fresh, modern design inspired by the contemporary lines of minimal aesthetics. The sophisticated shape of the handle – consisting of a vertical groove in the door edge and of an inner surface that can be customised in lacquered, wood finishes or in matt and glossy metal finishes – is reminiscent of the tapered profile of a wing. The doors come in an even wider range of finishes, available in glass, mirror, wood and lacquer, coordinated with or differing from the handle for a tone-on-tone or contrasting effect.



Manhattan armadio con apertura battente. Ante Frassino Miele, maniglia Champagne opaco. Interni Duna laccato opaco Ecrù, schienali Duna laccato opaco Fango. / Manhattan wardrobe with Frassino Miele hinged doors and matt Champagne handle. Ecrù Duna matt lacquered interior, Fango Duna matt lacquered back panels.





1 — Manhattan armadio battente. Ante vetro Metallizzato Bronzo, fianchi laccato opaco Ecrù. Maniglia Titanio Opaco. / Manhattan hinged door wardrobe. Metallizzato Bronzo glass doors, Ecrù matt lacquered sides. Matt Titanio handle.



2 — Manhattan scorrevole. Ante e fianchi laccato lucido Fango, maniglia Borgogna. / Manhattan sliding door wardrobe. Fango high gloss lacquered doors and sides, Borgogna handle.





IT Come in una boutique personale, i propri oggetti e i propri capi di abbigliamento diventano elementi da valorizzare, da esporre con eleganza ed ordine. Le ante in vetro, definite da un telaio verniciato in finitura Canna di Fucile o Palladio enfatizzano ed impreziosiscono le composizioni. Le attrezzature interne a vista dimostrano grande capacità di organizzare con efficacia e raffinatezza lo spazio. Speciale è anche l'apertura cardine delle ante, che può raggiungere un angolo di 180°, con cerniere a perno.

EN Just as if they were arranged in a personal boutique, your objects and garments must be enhanced and exhibited with elegance and order. The glass doors, defined by a metal frame in Canna di Fucile or Palladio finishes, set off and add a finishing touch to your wardrobe. The visible interior accessories show off their great ability to efficiently organise spaces with style. The Cardine hinged doors come with special pivot hinges that can open at a 180° angle.



Milano armadio con apertura cardine. Ante vetro Rigato Argento, telaio Canna di Fucile. Interni materico Perlage Terra e Duna laccato opaco Mattone. / Milano wardrobe with cardine hinged doors in Rigato Argento glass, Canna di Fucile frame. Perlage Terra materico and Mattone Duna matt lacquered interior.

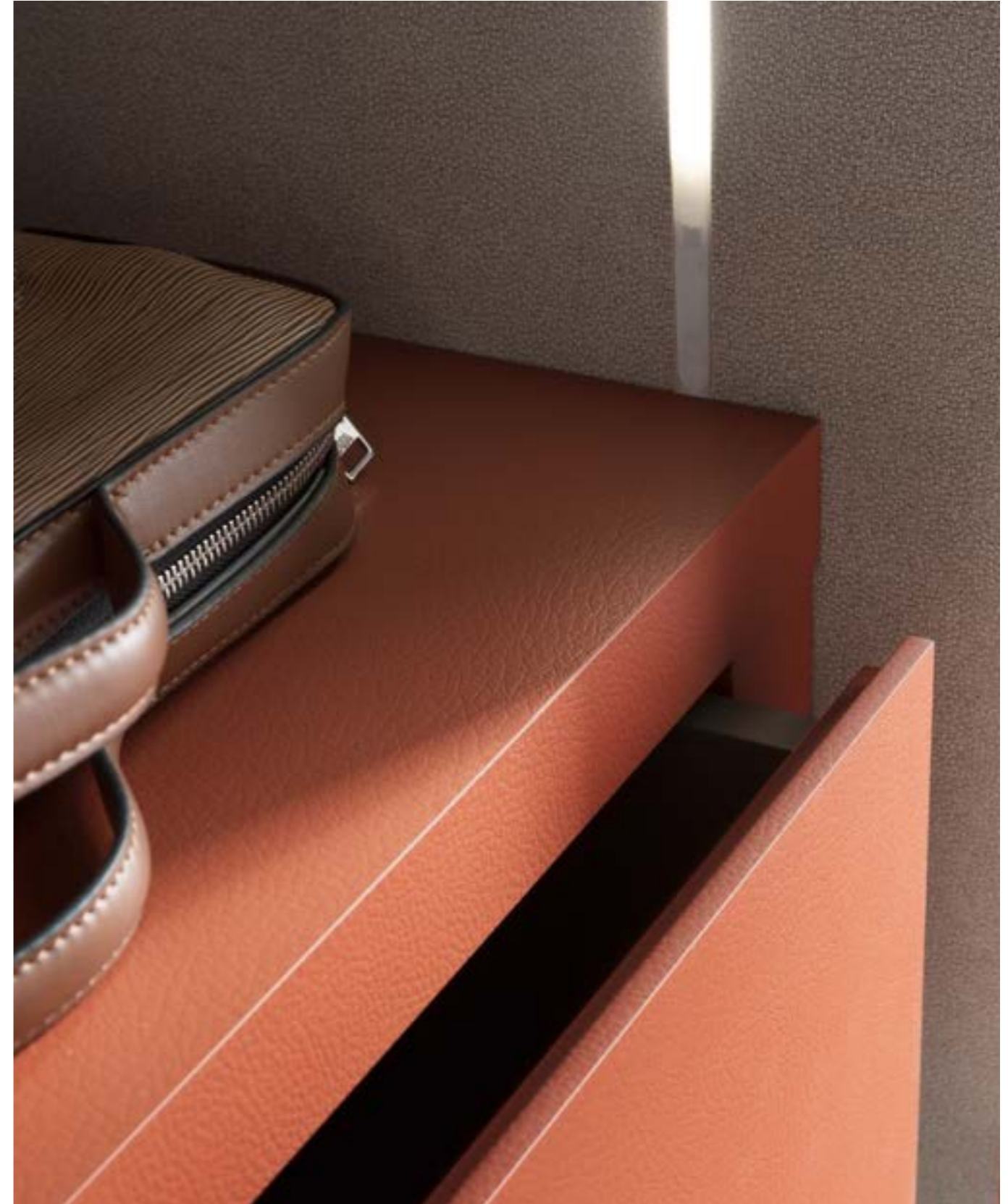

1 — Milano armadio cardine. Ante vetro Trasparente Piombo, fianchi laccato opaco Fango, telaio Palladio. Interni Perlage Terra. / Milano cardine hinged door wardrobe. Trasparente Piombo glass doors, Fango matt lacquered sides, Palladio frame. Perlage Terra materico interior.



2 — Milano armadio cardine. Ante vetro Trasparente Argento, fianchi laccato opaco Cashmere, telaio Palladio. Interni materico Borgogna e Duna laccato opaco Cashmere. / Milano cardine hinged door wardrobe. Trasparente Argento glass doors, Cashmere matt lacquered sides, Palladio frame. Borgogna materico and Cashmere Duna matt lacquered interior.





IT Superfici continue, essenziali come la materia di cui sono fatte. Il telaio perimetrale è pensato alla stregua della cornice di un'opera d'arte: la sezione "smussata" incornicia con discrezione e sobrietà, senza imporsi con la sua estetica. Le ante, disponibili in vetro nelle sue numerose declinazioni, svelano i contenuti con eleganza e candore. Nella versione scorrevoe e complanare presentano un profilo orizzontale in tinta con il telaio, disponibile nelle finiture Palladio e Canna di Fucile: un dettaglio delicato e raffinato, che scandisce le superfici e ne valorizza le geometrie.

EN Flowing surfaces, as simple as the material they are made of. The perimeter frame is designed to resemble the frame of a work of art: the "bevelled" section provides a discreet yet elegant frame. The doors, available in several glass finishes, reveal the contents with an elegant, fresh style. In the sliding and flush sliding versions, they feature a horizontal profile to match the frame, available in Palladio and Canna di Fucile finishes: a delicate, refined detail that highlights the surfaces and accentuates the structure.



Murano armadio con apertura scorrevole. Ante vetro Trasparente Argento, telaio Canna di Fucile. Interni Noce Dorato e Duna laccato opaco Ecrù. / Murano wardrobe with sliding doors in Trasparente Argento glass doors, Canna di Fucile frame. Noce Dorato materico and Ecrù Duna matt lacquered interior.





1 — Murano armadio battente. Ante vetro Metallizzato Piombo, fianchi laccato opaco Piombo, telaio Canna di Fucile. / Murano hinged door wardrobe. Metallizzato Piombo glass doors, Piombo matt lacquered sides, Canna di Fucile frame.



2 — Murano armadio scorrevole. Ante vetro Rigato Bronzo, fianchi laccato opaco Seta, telaio e traversa orizzontale Palladio. Interno Duna laccato opaco Seta. / Murano sliding door wardrobe. Rigato Bronzo glass doors, Seta matt lacquered sides, Palladio frame and horizontal trim. Seta Duna matt lacquered interior.



3 — Murano armadio complanare. Ante vetro marmo Calacatta opaco, fianchi laccato opaco Lavagna, telaio e traversa orizzontale Canna di Fucile. / Murano flush sliding door wardrobe. Matt Calacatta marble glass doors, Lavagna matt lacquered sides, Canna di Fucile frame and horizontal trim.



IT Lo stile sobrio e delicato della semplicità incontra la massima possibilità di espressione e personalizzazione. Per soddisfare qualunque esigenza estetica e funzionale, Nastro offre una vasta gamma di finiture e soluzioni speciali: cassettera esterna, modulo a ponte, sovrapporta, tv, oltre alle lavorazioni su misura. Incassate nelle ante, le maniglie in alluminio a tutta altezza delineano gole dai colori laccati o dalle finiture metalliche opache e lucide.

EN The understated and delicate style of simplicity meets the ultimate in expressiveness and customisation. Nastro offers a vast range of finishes and special solutions to satisfy any aesthetic and functional needs: external drawer unit module, bridge module, unit installed above doors, TV unit as well as custom-sized solutions. Recessed in the doors, the aluminium, full-height handles are available in lacquered colours or in matt and glossy metal finishes.



Nastro armadio con apertura battente. Ante vetro Metallizzato Argento, maniglia laccato opaco Lavagna. Interni materico Borgogna. / Nastro hinged door wardrobe in Metallizzato Argento glass, Lavagna matt lacquered handle. Borgogna materico interior.



1 — Nastro armadio battente. Ante e fianchi laccato opaco Mattone, maniglia laccato opaco Nero. / Nastro hinged door wardrobe. Mattone matt lacquered doors and sides, Nero matt lacquered handle.



2 — Nastro armadio scorrevole. Ante laccato opaco Seta, fianchi laccato opaco Seta, maniglia Bronzo lucido. / Nastro sliding door wardrobe. Seta matt lacquered doors, Seta matt lacquered sides, glossy Bronzo handle.



3 — Nastro armadio complanare. Ante e fianchi Frassino Miele, maniglia Champagne opaco. / Nastro flush sliding door wardrobe. Frassino Miele doors and sides, matt Champagne handle.





IT Essenziale nel tratto, rigoroso nella scansione geometrica, autentico nel carattere: un inno alla bellezza delle cose semplici, alla cura dei dettagli e alla pulizia formale. La sua modularità permette di includere numerosi vani speciali, come il modulo home office o quello a ponte con scrittoio, che aggiungono nuove funzioni e ampliano le possibilità compositive. Disponibile nella versione battente, complanare, scorrevole, Plana è proposto inoltre con l'apertura "cardine" che permette di aprire le ante di 180°, come le porte e i mobili di pregio artigianali di un tempo. Ampia la gamma di maniglie abbinabili: per personalizzarne lo stile e donare all'armadio un tocco unico.

EN With its simple lines, rigorous shape and authentic character, it pays tribute to the beauty of simple things, meticulous detailing and clean design. Its modular options allow for the inclusion of numerous special compartments, like the home office module or the bridge module with desk, which add new functions to the arrangement options. Available as hinged, flush sliding and sliding versions, Plana is also available with a cardine hinged opening that allows the doors to open 180°, like the doors and fine hand-crafted furniture of the past. There is a wide range of matching handles, to personalise the style and give the wardrobe a unique touch.



Plana armadio con apertura battente. Ante laccato lucido Seta, maniglia Q15 Champagne opaco con inserto cuoio Hermes. Schieneali materico Bon Ton, ripiani vetro Trasparente Piombo, cassettiere Duna laccato opaco Seta. / Plana wardrobe with Seta high gloss lacquered hinged doors, matt Champagne Q15 handle with Hermes hard leather insert. Bon Ton materico back panels, Trasparente Piombo glass shelves, Seta Duna matt lacquered drawer units.





1 — Plana armadio battente. Ante e fianchi materico Larice Tortora, maniglia Y110 Titanio opaco. / Plana hinged door wardrobe. Larice Tortora materico doors and sides, matt Titanio Y110 handle.



2 — Plana armadio cardine. Ante e fianchi Canaletto, maniglia C25 cuoio Moro. / Plana cardine hinged door wardrobe. Canaletto doors and side, Moro hard leather C25 handle.



3 — Plana armadio scorrevole. Ante e fianchi laccato opaco Cashmere, maniglia W110 Canaletto. / Plana sliding door wardrobe. Cashmere matt lacquered doors and sides, Canaletto W110 handle.



4 — Plana armadio complanare. Ante e fianchi laccato opaco Mirto, maniglia Q15 Titanio opaco con inserto Borgogna. / Plana flush sliding door wardrobe. Mirto matt lacquered doors and sides, matt Titanio Q15 handle with Borgogna insert.



## Maniglie Plana / Plana Handles

- 1 — Maniglia A18 Titanio opaco. / Matt Titanio A18 handle.
- 2 — Maniglia A39 Canaletto / Canaletto A39 handle.



- 3 — Maniglia A84 Titanio opaco. / Matt Titanio A84 handle.



1 — Maniglia Q15 Titanio opaco con inserto cuoio Moro. / Matt Titanio Q15 handle with Moro leather insert.

2 — Maniglia Y30 Titanio opaco. / Matt Titanio Y30 handle.



3 — Maniglia Y110 Titanio opaco. / Matt Titanio Y110 handle.



- 1 — Maniglia B12 cuoio Moro. / Moro leather B12 handle.
- 2 — Maniglia C25 cuoio Moro. / Moro leather C25 handle.



- 3 — Maniglia L110 Titanio opaco. / Matt Titanio L110 handle.



1, 2 – Maniglia H5 per  
anta scorrevole in finitura  
Brunita. / Burnished H5  
handle for sliding door.



3 – Chiave cuoio Moro. /  
Moro leather Key.  
4 – Apertura Push-Pull.  
/ Push-Pull opening.



5 – Maniglia W110  
Canaletto. / Canaletto  
W110 handle





Raggio by CRS Pianca

IT Lussuosa, unica ed elegante, la decorazione diventa protagonista. A catturare lo sguardo sono le incisioni verticali che percorrono la superficie dell'anta, alternandosi come raggi discontinui e disegnando dinamici motivi paralleli. Lucide o opache, impreziosiscono i vetri e gli specchi delle ante. Le maniglie sono ricavate a tutta altezza all'interno dell'anta e sono realizzate in alluminio laccato o con finitura metallizzata opaca e lucida.

EN Lush, unique and elegant embellishments steal the show. Vertical etchings run across the surface of the door, alternating like discontinuous rays of light that sketch dynamic, parallel lines. Gloss or matt, they embellish the glass or mirrored door surfaces. The handles run along the whole height of the door edge and come in a lacquered aluminium or metallic finish.



Raggio armadio con apertura scorrevole. Ante e fianco di finitura specchio Bronzo, maniglia Bronzo opaco. Interni materico Perlage Terra e materico Borgogna. Telai estraibili con cesto portabiancheria in tessuto. / Raggio sliding door wardrobe with doors and finished sides in Bronzo mirror, matt Bronzo handle. Perlage Terra materico and Borgogna materico interior. Pull-out frames with fabric hamper.

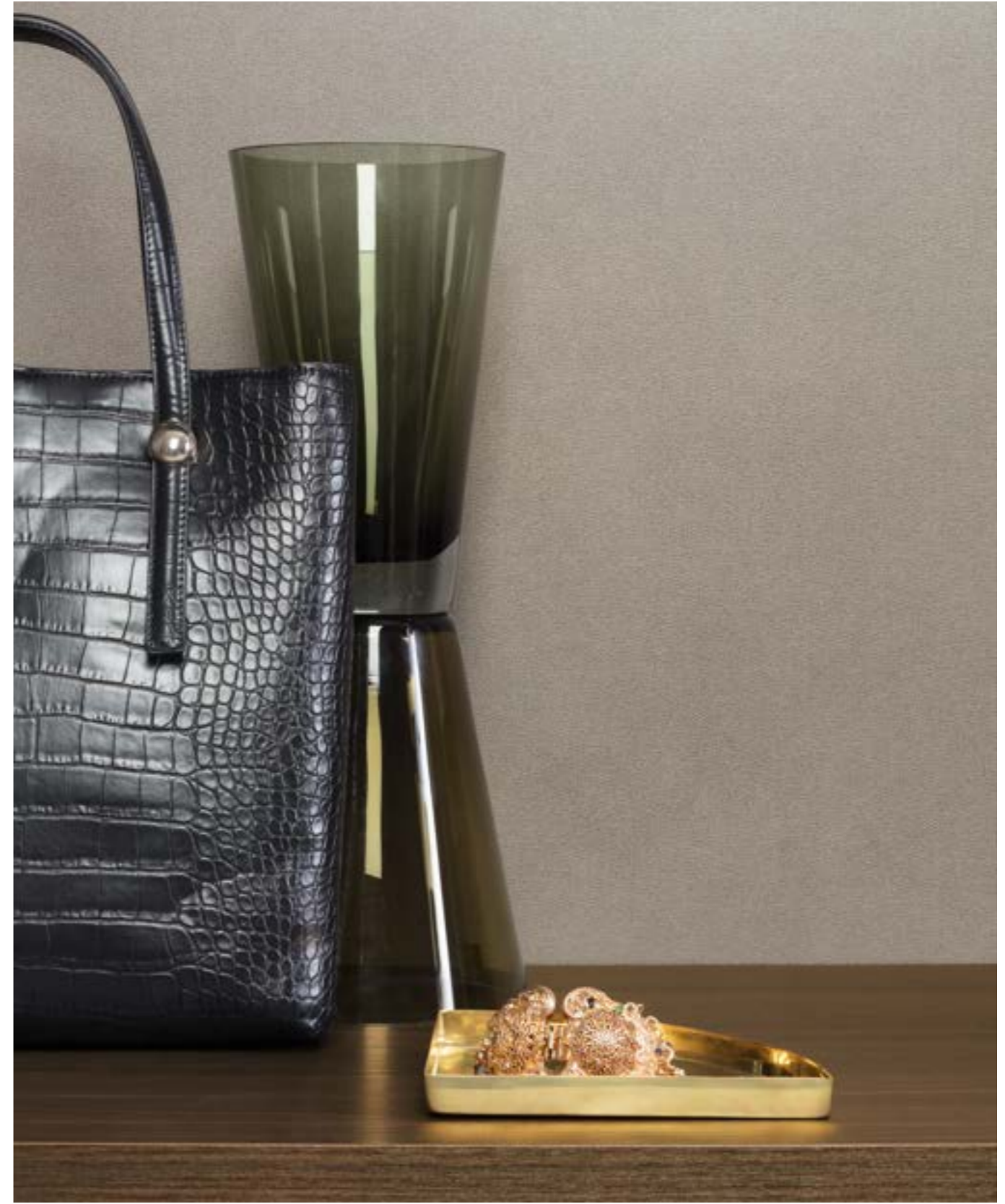



1 — Raggio armadio battente. Ante specchio Piombo, fianchi laccato opaco Piombo, maniglia laccato opaco Nero. / Raggio hinged door wardrobe. Piombo mirror doors, Piombo matt lacquered sides, Nero matt lacquered handle.



2 — Raggio armadio scorrevole. Ante vetro laccato opaco Seta, fianchi laccato opaco Seta, maniglia laccato opaco Seta. / Raggio sliding door wardrobe. Seta matt lacquered glass doors, Seta matt lacquered sides, Seta matt lacquered handle.



3 — Raggio armadio complanare. Ante vetro laccato lucido Seta, fianchi laccato opaco Seta, maniglia laccato opaco Seta. / Raggio flush sliding door wardrobe. Seta glossy lacquered glass doors, Seta matt lacquered sides, Seta matt lacquered handle.



Tratto by CRS Pianca

IT Una convivenza imbattibile quella tra minimalismo estetico e funzionalità. È una semplicità che conquista per la sua coerenza e la forza della sua essenzialità. Tratto integra e fonde gli elementi dell'anta, ricavando la maniglia all'interno del pannello di legno. Scavata in senso verticale e prossima al bordo dell'anta, garantisce una presa sicura sia nella versione con apertura a battente che scorrevole. Uniformità materica, anche nelle finiture, a scelta tra i laccati e le essenze della collezione.

EN Aesthetic minimalism and functionality are an unbeatable combo. This wardrobe's success lies in its consistent simplicity and in the power of its minimal lines. Tratto integrates and blends the door parts while carving the handle out of the panel. Vertically recessed near the edge of the door, it offers a sound grip on both hinged and sliding doors. Available in all the lacquers and wood types of the collection.



Tratto armadio con apertura scorrevole. Ante Canaletto. Interni Materico Noce Dorato e Duna laccato opaco Lavagna. Ripiani vetro Trasparente Piombo con cornice Duna laccato opaco Lavagna. / Tratto wardrobe with Canaletto sliding doors. Noce Dorato materico and Lavagna Duna matt lacquered interior. Trasparente Piombo glass shelves with Lavagna Duna matt lacquered frame.



1 — Tratto armadio battente. Ante laccato lucido Cenere, fianchi laccato opaco Cenere. / Tratto hinged door wardrobe. Cenere high gloss lacquered doors, Cenere matt lacquered sides.



2 — Tratto armadio scorrevole. Ante e fianchi Frassino Lino. / Tratto sliding door wardrobe. Frassino Lino doors and sides.



IT Le suggestioni degli armadi di una volta vengono rivestite di un nuovo senso, grazie a un linguaggio contemporaneo e al tempo stesso evocativo. Carico di fascino di antichi ricordi, Verona riscopre la scansione classica a cornice delle ante e gioca con quadri di dimensioni differenti. Nascono incontri di linee verticali e orizzontali, composizioni simmetriche e asimmetriche. Un incavo nella cornice del telaio, ottenuto dalla lavorazione del montante, assicura un'apertura discreta, senza maniglie a vista. È il senso di una eleganza discreta e misurata, senza tempo.

EN Charming wardrobes of times gone by are given a new meaning with a contemporary yet evocative design language. The Verona wardrobe, steeped in the charm of distant memories, is a new take on the classic framed door fronts and plays with squared forms of different dimensions. Vertical and horizontal lines, and symmetrical and asymmetrical compositions come together as one. A recess in the frame, achieved by the design of the vertical support, ensures a discreet opening without visible handles. This creates a sense of discreet, measured, timeless elegance.



Verona armadio con apertura battente. Ante laccato opaco Cipria. Interni materico Noce Dorato, frontali cassetto Miro vetro Rigato Bronzo con telaio Palladio. / Verona wardrobe with Cipria matt lacquered hinged doors. Noce Dorato materico interior, Miro drawer fronts in Rigato Bronzo glass with Palladio frame.

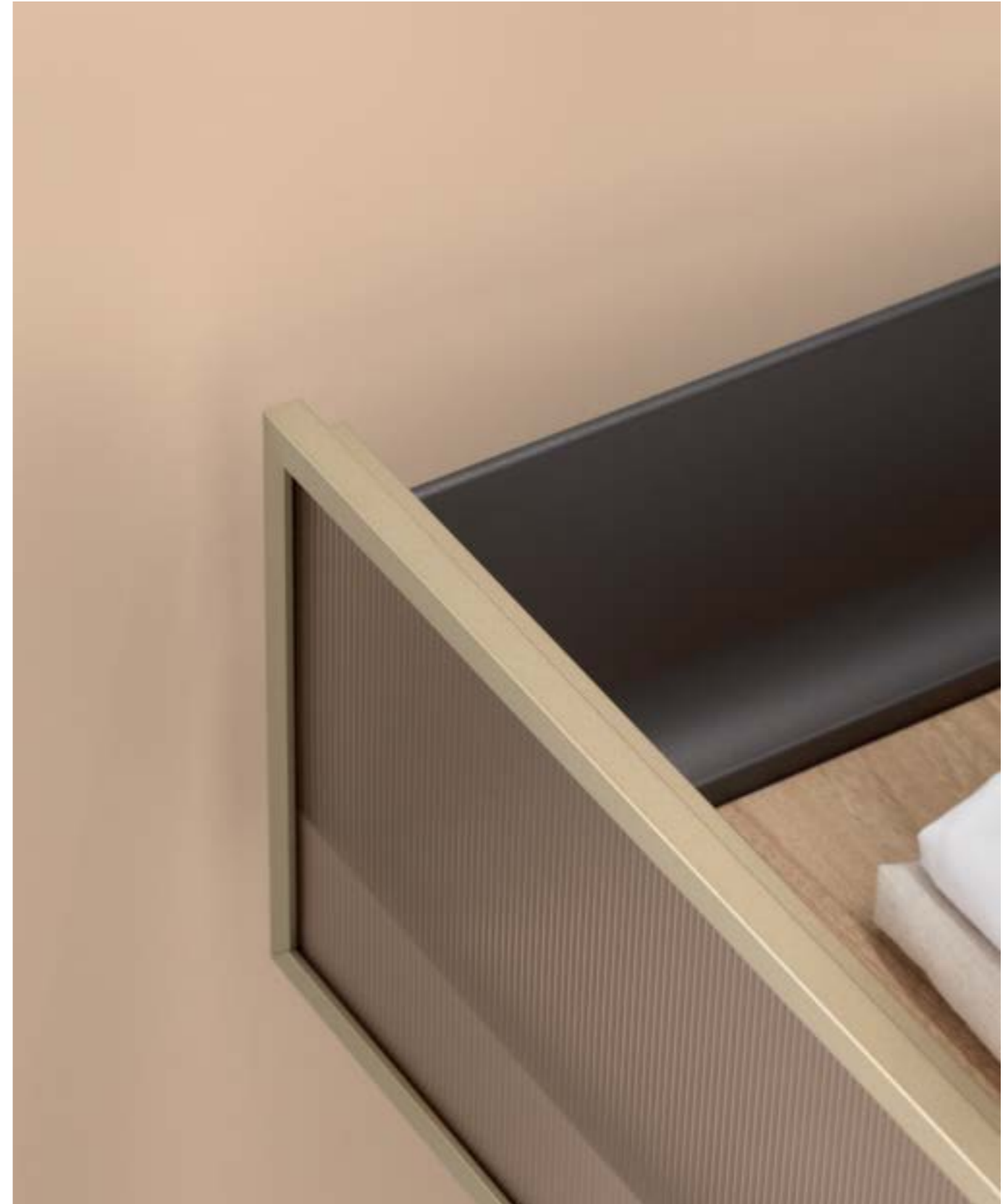



1 — Verona armadio battente. Ante e fianchi Frassino Nero. / Verona hinged door wardrobe. Frassino Nero doors and sides.



2 — Verona armadio complanare. Ante e fianchi laccato opaco Cashmere. / Verona flush sliding door wardrobe. Cashmere matt lacquered doors and sides.





IT Rigore, funzione ed eleganza. Grazie al suo design lineare e all'assenza di maniglie, questa anta scorrevole si abbina perfettamente ai diversi modelli di armadi per cui è disponibile: Amalfi, Cornice, Icona, Manhattan, Nastro, Plana, Raggio, Tratto. Il vano rientrante è pensato per ospitare il televisore che, incorniciato come un quadro, diventa parte integrante dell'anta senza comprometterne i volumi e i profili. All'interno è possibile attrezzare il vano con tutti gli accessori della collezione Pianca, per non rinunciare a ordine e funzionalità.

EN Precision, functionality and elegance. Thanks to its linear, handle-less design, this sliding door perfectly matches the different wardrobe models for which it is available: Amalfi, Cornice, Icona, Manhattan, Nastro, Plana, Raggio and Tratto. The recessed module is designed to accommodate the TV set, which is framed like a picture and is an integral part of the door without compromising its volume and shape. You can fit out the wardrobe modules with all the accessories from the Pianca collection, to keep things orderly and tidy.



Plana armadio scorrevole con Anta TV laccato opaco Fango, ante laterali Borgogna con maniglia Y 30 Titanio opaco. / Plana sliding door wardrobe with Fango matt lacquered TV door, Borgogna lateral doors with matt Titanio Y 30 handle. .

1 — Cornice armadio scorrevole con Anta TV laccato opaco Espresso, ante laterali in pelle sintetica Talpa con maniglia e telaio Alluminio Anodizzato Nero, fianchi laccato opaco Espresso. / Cornice sliding door wardrobe with Espresso matt lacquered TV Door, Talpa synthetic leather lateral doors with handle and frame in Black Anodized Aluminium, Espresso matt lacquered sides.



2 — Manhattan armadio scorrevole con Anta TV laccato opaco Ecrù, ante laterali laccato opaco Ecrù con maniglie Titanio opaco, fianchi laccato opaco Ecrù. / Manhattan sliding door wardrobe with Ecrù matt lacquered TV Door, Ecrù matt lacquered lateral doors with matt Titanio handles, Ecrù matt lacquered sides.



3 — Nastro armadio scorrevole con Anta TV laccato opaco Fango, ante laterali materico Larice Tortora con maniglie Titanio opaco, fianchi laccato opaco Fango. / Nastro sliding door wardrobe with Fango matt lacquered TV Door, Larice Tortora materico lateral doors with matt Titanio handles, Fango matt lacquered sides.



4 — Amalfi armadio scorrevole con Anta TV laccato opaco Lavagna, ante laterali Frassino Nero con maniglia Canna di Fucile, fianchi laccato opaco Lavagna. / Amalfi sliding door wardrobe with Lavagna matt lacquered TV Door, Frassino Nero lateral doors with Canna di Fucile handle, Lavagna matt lacquered sides.





IT Non solo abiti e ripiani, ma un vano pensato per offrire una soluzione di lavoro inaspettata e intima. Lo scrittoio Ala con cassetti, mensole e moduli a giorno creano uno spazio funzionale e misurato, delicatamente racchiuso dietro ante che dissimulano forme e funzioni. Dettagli pensati come piccoli virtuosismi di ebanisteria, l'uso sapiente delle luci a scomparsa e la presenza delle più moderne soluzioni per l'uso degli spazi da ufficio, rendono il vano Home Office uno strumento adatto ad interpretare la fluidità della vita di oggi. Abbinabile alle ante Milano, Plana e Amalfi, per molteplici configurazioni e stili.

EN Not just clothes and shelves, but a space designed to offer an unexpected, intimate workspace. The Ala desk with drawers, shelves and open modules creates a functional, compact space, discreetly stowed away behind doors that conceal forms and functions. Every detail is inspired by traditional cabinet making. The skilful use of hidden lighting and the inclusion of highly modern solutions for office space use, make the Home Office module a unit well-suited to interpreting the fluidity of contemporary life. It can be combined with the Milano, Plana and Amalfi doors, for multiple configurations and styles.



Amalfi armadio con apertura cardine e modulo home office. Ante laccato opaco Avio, maniglia Canna di Fucile. Schienali Borgogna. Ripiani, moduli a giorno con luce Led e scrittoio laccato opaco Avio. / Amalfi cardine hinged door wardrobe with home office module. Avio matt lacquered doors, Canna di Fucile handle. Borgogna back panels. Avio matt lacquered shelves, open modules with LED light and desk.

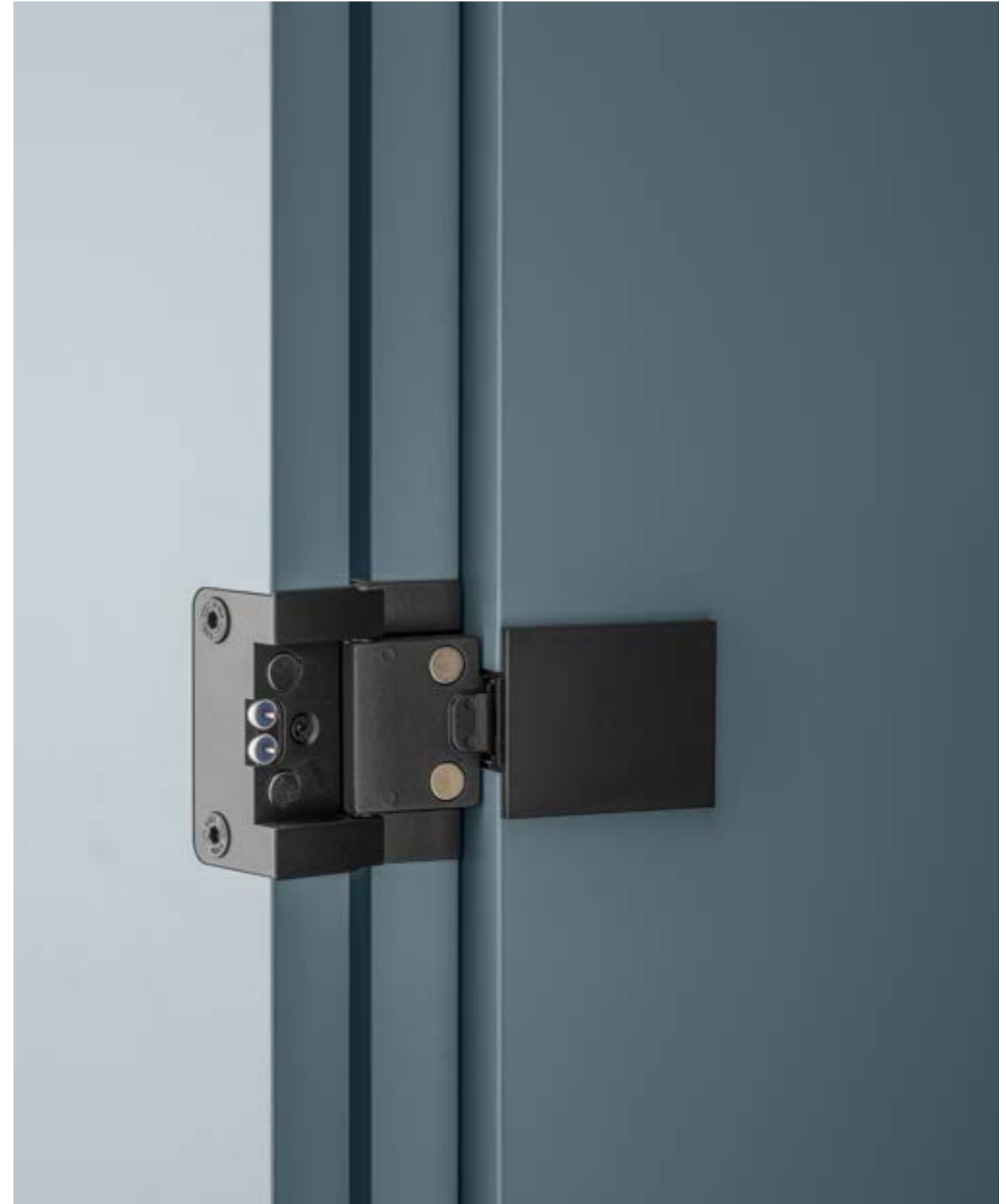
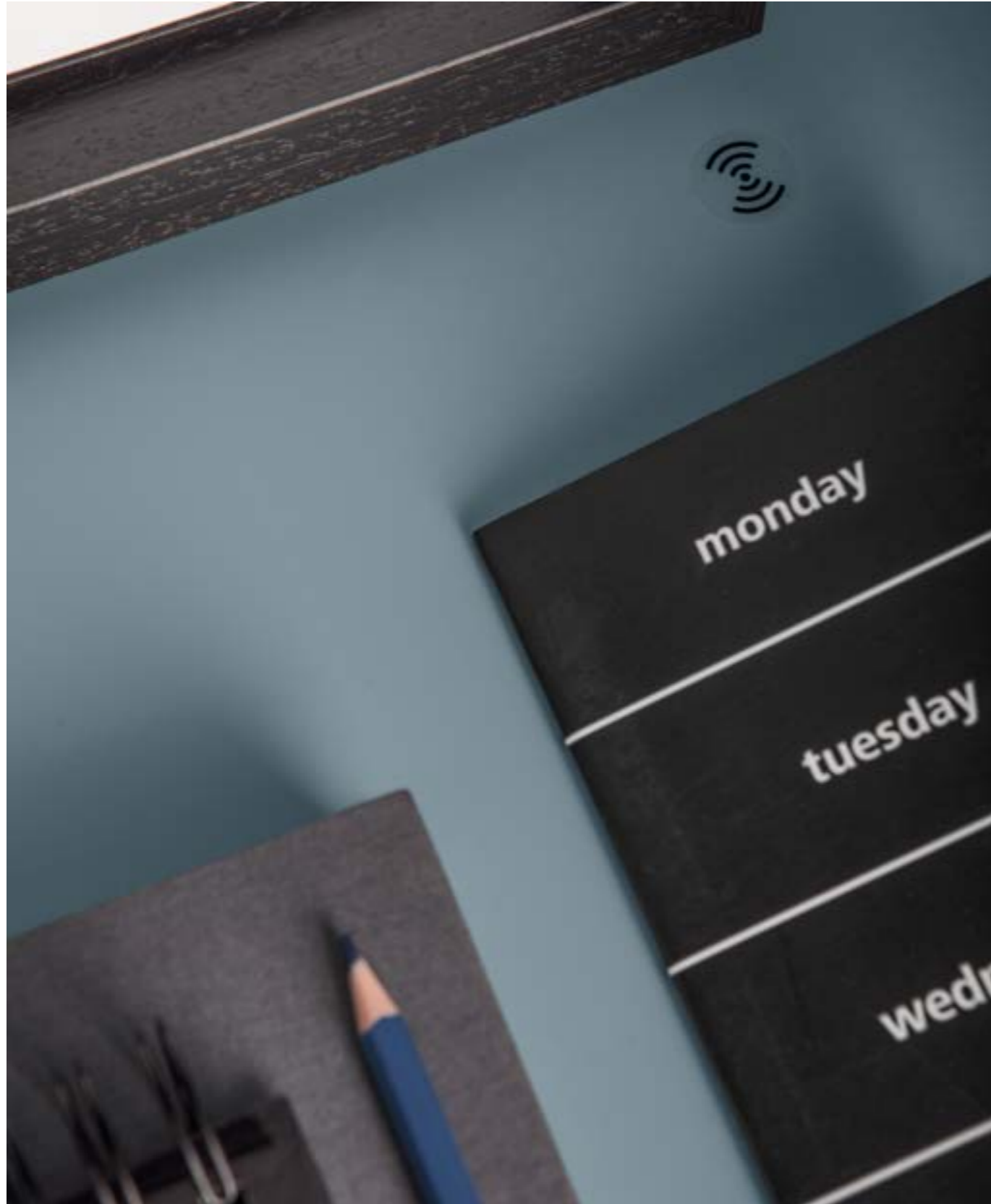

1 — Milano

Ante vetro Trasparente Bronzo, telaio Palladio. Modulo Home Office con schienali, ripiani e divisori laccato opaco Mirto. Scrivania Ala laccato opaco Mirto con frontali cassetto cuoio Nero. / Trasparente Bronzo glass doors, Palladio frame. Home Office module with Mirto matt lacquered back panels, shelves and partitions. Mirto matt lacquered Ala desk with Nero hard leather drawer fronts.



2 — Plana

Ante Canaletto, maniglia C25 cuoio Moro. Modulo Home Office con schienali, ripiani e divisori laccato opaco Mattone. Scrivania Ala laccato opaco Mattone con frontali cassetto cuoio Moro. / Canaletto doors, Moro C25 hard leather handle. Home Office module with Mattone matt lacquered back panels, shelves and partitions. Mattone matt lacquered Ala desk with Moro hard leather drawer fronts.



3 — Amalfi

Ante laccato opaco Avio, maniglia Canna di Fucile. Modulo Home Office con schienali Borgogna. Ripiani, moduli a giorno e scrivania laccato opaco Avio. / Avio matt lacquered doors, Canna di Fucile handle. Home Office module with Borgogna back panels. Avio matt lacquered shelves, open modules and desk.





# Cabine e complementi / Walk-in closet and complements



Anteprima p.128



Sipario p.140



Teatro p.152



Teatro con anta Murano /  
Teatro with Murano door  
p.164



Vista p.172



Island up p.180



IT Scegliere quali capi di abbigliamento indossare, che scarpe ed accessori abbinare è un rito che compiamo nella quotidianità e nelle occasioni speciali. Anteprima nasce per accompagnare ed ispirare i nostri gesti. Soluzioni pratiche ed affascinanti, dotate della massima libertà compositiva ed ampiamente personalizzabili nelle finiture, rispondono alle più esigenti richieste. Disponibile con o senza schienali, la struttura può essere completata con elementi modulari di ogni genere, come ripiani, cassettiere, raster pensili, appenderie.

EN In our everyday life – as well as on special occasions – we repeat the ritual of choosing what clothes to wear and which shoes and accessories to use with them. Anteprima has been designed to accompany and inspire our choices. Practical, fascinating elements allow unsurpassable freedom of arrangements and can be customised in a wide range of finishes to meet the most demanding requests. Available with or without back panels, the structure can be completed by a wide range of accessories such as shelves, drawer units, suspended cubbies and hangers.



Anteprima cabina con schienali pelle sintetica Creta e specchio Argento. Ripiani e portascarpe materico Borgogna, ripiani vetro Trasparente Piombo con cornice Manganese. Cassettiere con struttura materico Borgogna e frontali vetro marmo Amani opaco. Moduli a giorno Borgogna con contenitori cuoio Nero. / Anteprima closet with Creta synthetic leather and Argento mirror back panels. Borgogna materico shelves and shoe rack, Trasparente Piombo glass shelves with Manganese frame. Drawer units with Borgogna materico structure and matt Amani marble glass fronts. Borgogna open modules with Nero hard leather boxes.





Anteprima cabina con schienali materico Bon Ton. Moduli raster, ripiani e portascarpe materico Bon Ton. Cassettera con struttura materico Bon Ton, frontali cassetto Miro vetro Trasparente Piombo e telaio Canna di Fucile. / Anteprima closet with Bon Ton materico back panels. Bon Ton materico cubbies, shelves and shoe rack. Drawer unit with Bon Ton materico structure, Miro drawer fronts in Trasparente Piombo glass with Canna di Fucile frame.



1 — Anteprima cabina con schienali Larice Tortora, ripiani portascarpe Duna laccato opaco Ecrù, frontali cassetto vetro Metallizzato Bronzo. / Anteprima closet with Larice Tortora materico back panels, Ecrù Duna matt lacquered shelves and shoe rack, Metallizzato Bronzo glass drawer fronts.



3 — Anteprima cabina con schienali materico Borgogna e vetro Metallizzato Bronzo, ripiani, portascarpe e frontali cassetto materico Borgogna. / Anteprima closet with materico Borgogna back panels and Metallizzato Bronzo glass, materico Borgogna shelves, shoe racks and drawer fronts.



2 — Anteprima cabina con schienali materico Bon Ton, ripiani e portascarpe materico Noce Biondo, frontali cassetto Duna laccato opaco Onice. / Anteprima closet with Bon Ton materico back panels, Noce Dorato materico shelves and shoe rack, Onice Duna matt lacquered drawer fronts.



4 — Anteprima cabina con schienali Duna laccato opaco Seta, ripiani, portascarpe e frontali cassetto materico Bon Ton. / Anteprima closet with Seta Duna matt lacquered back panels, Bon Ton materico shelves, shoe rack and drawer fronts.





IT Scompaiono i filtri e in scena si combinano eleganza, ordine e raffinatezza. Sipario si compone di moduli armadio senza ante, da accostare in modo libero secondo le proprie esigenze pratiche ed il proprio gusto estetico. Vasta la scelta delle finiture, esaltate, nella versione con telaio, dalla presenza di un'ampia cornice perimetrale che dona alle composizioni un'atmosfera ancora più calda e sofisticata. La gamma di accessori interni è la stessa disponibile per gli armadi ed è in grado di soddisfare ogni esigenza.

EN Curtains dissolve to reveal elegance, order and refinement on stage. Sipario is made up of wardrobe modules without doors that can be unrestrictedly put together to suit individual practical requirements and aesthetic preferences. In the framed version, the vast array of finishes is enhanced by a wide frame that gives the arrangement an even warmer and more sophisticated appeal. To satisfy any requirement, our range of interior accessories is the same available for our wardrobes.





Sipario cabina struttura materico Noce Dorato con telai laccato opaco Ecrù, schiene materico Bon Ton. Cassettiera, moduli raster e ripiani materico Noce Dorato, scatole per raster pelle sintetica Elephant. / Sipario closet with Noce Dorato materico structure and Ecrù matt lacquered frames, Bon Ton materico back panels. Noce Dorato materico drawer unit, cubbies and shelves, cubby boxes in Elephant synthetic leather.





Sipario cabina senza telai, struttura materico Perlage Terra, schienali materico Larice Tortora. Cassettiere, ripiani e divisori materico Perlage Terra. / Sipario closet without frames, Perlage Terra materico structure, Larice Tortora materico back panels. Drawer units, shelves and partitions in Perlage Terra materico.



1 — Sipario cabina struttura e schienali Duna laccato opaco Seta con telai laccato opaco Seta. Ripiani e frontale telaio estraibile materico Bon Ton, frontali cassetto vetro marmo Amani opaco. / Sipario closet with Seta Duna matt lacquered back panels and structure and Seta matt lacquered frames. Shelves and pull-out frame front in Bon Ton materico, matt Amani marble glass drawer fronts.



3 — Sipario cabina struttura e schienali materico Noce Dorato con telai laccato opaco Espresso. Ripiani, frontale telaio estraibile Duna laccato opaco Espresso, frontali cassetto in pelle sintetica Talpa. / Sipario closet with Noce Dorato materico structure and back panels, Espresso matt lacquered frames. Espresso Duna matt lacquered pull-out frame front and shelves, drawer fronts in Talpa synthetic leather.



2 — Sipario cabina struttura Duna laccato opaco Lavagna con telai, ripiani e frontale telaio estraibile materico Borgogna, frontali cassetto Miro vetro Trasparente Piombo con cornice Canna di Fucile. / Sipario closet with Lavagna Duna matt lacquered structure and Borgogna materico frames, shelves and pull-out frame front. Miro drawer fronts in Trasparente Piombo glass with Canna di Fucile frame.



4 — Sipario cabina struttura Duna laccato opaco Roccia con telai laccato opaco Roccia. Schienali, ripiani e frontale telaio estraibile materico Perlage Conchiglia, frontali cassetto vetro Metallizzato Piombo. / Sipario closet with Roccia matt lacquered frames and Roccia Duna matt lacquered structure. Perlage Conchiglia materico back panels, shelves and pull-out frame front, Metallizzato Piombo glass drawer fronts.





IT Trasparenza, leggerezza, linearità. La struttura portante di questa cabina diventa geometria visibile e caratterizzante, discreta cornice per ogni contenuto, perfetta per ogni ambiente e stile. I divisori a telaio passanti, senza pannelli interni, assicurano continuità visiva e spaziale, enfatizzando la leggerezza dell'architettura e dei volumi. La struttura permette il posizionamento della cabina sia a parete, sia a centro stanza, per rendere Teatro un elemento isola protagonista di ambienti e progetti. La possibilità di includere schienali e fianchi arricchisce le opportunità di personalizzazione, rendendola perfetta per adattarsi ad ogni stile.

EN Transparency, lightness and simplicity. The supporting structure of this closet adopts a visible, distinctive structure and a discreet frame for any content, making it perfect for every environment and style. The dividing partitions, with no interior panels, ensure visual and spacial continuity, emphasising the lightness of this design. The structure allows the closet to be installed against a wall, or in the centre of the room, making Teatro an island with a key role in different spaces and atmospheres. The option of adding back panels and sides gives plenty of scope for a custom design, making it the perfect solution for any style.



Teatro cabina con divisori Canna di Fucile. Schienali materico Borgogna e Duna laccato opaco Roccia. Base, Cappello, ripiani Duna laccato opaco Roccia. Ripiani vetro Trasparente Piombo con telaio Canna di Fucile. Telai estraibili e struttura cassettiere Duna laccato opaco Roccia, frontali cassetto Miro vetro Trasparnte Piombo con cornice Canna di Fucile. / Teatro closet with Canna di Fucile partitions. Borgogna materico and Roccia Duna Duna matt lacquered back panels. Roccia matt lacquered base, top and shelves. Trasparente Piombo glass shelves with Canna di Fucile frame. Roccia Duna matt lacquered pull-out frames and drawer units, Trasparente Piombo glass Miro drawer fronts with Canna di Fucile frame.







Teatro cabina con divisori Palladio e fianchi terminali vetro Rigato Argento. Schienali Duna laccato opaco Seta. Base, cappello, ripiani e portascarpe materico Perlage Conchiglia. Cassettiere Duna laccato opaco Seta. / Teatro closet with Palladio partitions and Rigato Argento glass sides. Seta Duna matt lacquered back panels. Perlage Conchiglia materico base, top, shelves and shoe racks. Seta matt Duna lacquered drawer units.



1 — Teatro cabina con divisori Canna di Fucile. Schienali materico Perlage Conchiglia. Base, cappello, ripiani Duna laccato opaco Lavagna, frontali cassetto Miro vetro Rigato Piombo con cornice Canna di Fucile. / Teatro closet with Canna di Fucile partitions. Perlage Conchiglia materico back panels. Lavagna Duna matt lacquered base, top and shelves. Rigato Piombo glass Miro drawer fronts with Canna di Fucile frame.



3 — Teatro cabina con divisori Canna di Fucile. Schienali materico Larice Tortora. Base, cappello, ripiani materico Bon Ton, frontali cassetto vetro laccato opaco Seta. / Teatro closet with Canna di Fucile partitions. Larice Tortora materico back panels. Bon Ton materico base, top and shelves. Seta matt lacquered glass drawer fronts.



2 — Teatro cabina con divisori Palladio. Schienali materico marmo Grafite opaco. Base, cappello, ripiani materico Borgogna, frontali cassetto in pelle sintetica Talpa. / Teatro closet with Palladio partitions. Matt Grafite marble materico back panels. Base, top and shelves in Borgogna materico, Talpa synthetic leather drawer fronts.



4 — Teatro cabina con divisori Palladio. Schienali Duna laccato opaco Seta. Base, cappello, ripiani materico Noce Dorato, frontali cassetto materico Bon Ton. / Teatro closet with Palladio partitions. Seta Duna matt lacquered back panels. Noce Dorato materico base, top and shelves. Bon Ton materico drawer fronts.





Teatro con anta Murano /  
with Murano door by CRS Pianca

IT La leggerezza della cabina Teatro incontra la finezza dell'anta Murano dando vita a una vera e propria vetrina espositiva, capace di valorizzare con discrezione ed eleganza sia gli ambienti sia i suoi contenuti. Perfetta a parete o a centro stanza, si rivela come una sintesi ideale tra visibile e invisibile, percepito e immaginato. Le ante a battente sono disponibili nelle eleganti finiture in vetro della collezione, così come gli schienali e i fianchi opzionali che permettono di creare diverse composizioni, giochi di luci e trasparenze. La ricercatezza delle finiture concorre al suo stile intramontabile e sofisticato.

EN The gracefulness of the Teatro closet combines with the refined Murano door to create a true display cabinet, capable of discreetly and elegantly enhancing both the room and its contents. Perfect on a wall or in the centre of a room, it provides the ideal balance between the visible and the invisible, the perceived and the imagined. The hinged doors are available with the collection's elegant glass finishes, as are the optional back panels and sides that allow you to create different compositions, light effects and transparencies. The refined finishes contribute to its timeless and sophisticated style.



Teatro cabina con anta Murano.  
Ante e fianchi vetro Traparente Bronzo.  
Divisori Palladio, schienali, base,  
cappello, raster e cassettiere materico  
Bon Ton. / Teatro closet with Murano  
door. Traspante Bronzo glass doors  
and sides, Palladio partitions, Bon  
Ton materico back panels, base, top,  
cubbies and drawer units.



1 — Teatro cabina con anta Murano. Ante e fianchi vetro Rigato Argento, telaio ante e divisori Canna di Fucile. Interni materico Noce Dorato e Duna laccato opaco Seta. Frontali cassetto Miro vetro Trasparente Piombo.  
 / Teatro closet with Murano doors. Rigato Argento glass doors and sides, Canna di Fucile door frames and partitions. Seta Duna matt lacquered and Noce Dorato materico interior. Trasparente Piombo glass Miro drawer fronts.



2 — Teatro cabina con anta Murano. Ante e fianchi vetro Trasparente Argento, telaio ante e divisori Palladio. Interni materico Borgogna e Duna laccato opaco Cashmere.  
 / Teatro closet with Murano doors. Trasparente Argento glass doors and sides, Palladio door frames and partitions. Borgogna materico and Cashmere Duna matt lacquered interior.



Vista by CRS Pianca



IT Si abbina alle cabine armadio Pianca con i toni della discrezione e della sobrietà, al fine di creare una divisione osmotica tra gli spazi. Pulizia formale, leggerezza, modularità al centimetro rendono Vista un sistema di chiusura minimale ed estremamente versatile. Caratteristica principale è la totale assenza di telai, in entrambe le versioni di anta, in legno e in vetro. Monorotaia o birotaia, la struttura dei binari in alluminio può essere fissata a parete, a soffitto o ad incasso, per un incredibile effetto a scomparsa

EN The perfect item to complement Pianca walk-in closets; available in multiple finishes these doors create an osmotic division between spaces. Formal cleanliness, lightness, modularity down to the centimeter make Vista a minimal and extremely versatile door system. The main feature is the total absence of frames, in both versions of these doors, in wood and in glass. Single or double track, the structure of the aluminum rails can be fixed to the wall, ceiling or recessed, for an incredible concealed effect.





Vista sistema di chiusura con binario monorotaia ad incasso, pannelli fissi e ante scorrevoli Crystal con maniglia gola in vetro Trama Argento. / Vista door system with built-in single track, Trama Argento glass fixed panels and Crystal sliding doors with groove handle.



Vista sistema di chiusura con binario monorotaia a soffitto, ante scorrevoli Plana materico Noce Dorato con maniglia U40 Titanio opaco. / Vista door system with single ceiling track, Noce Dorato materico Plana sliding doors with matt Titanio U40 handle.





Island up by CRS Pianca

IT Unicità e stile. Un modulo free-standing perfetto complemento delle cabine armadio Pianca che, come nelle più esclusive boutique, custodisce accessori preziosi, gioielli, beni carichi di ricordi e valore. Molteplici le tipologie di oggetti e capi che possono essere riposti al suo interno, grazie all'ampia possibilità di personalizzazione offerta dai complementi disponibili: cassetti, teche in vetro, ripiani, vassoi contenitori, porta scarpe. Pratica e funzionale nella versione con panca integrata: una comoda ed elegante soluzione, per offrire attimi di relax, immersi in un'atmosfera calda e ricercata.

EN Uniqueness and style. A free-standing module that is the perfect complement to Pianca walk-in closets which, as in the most exclusive boutiques, houses deluxe accessories, jewellery and valuable items steeped in memories. There are many types of objects and garments that can be stored inside, the many accessories offered include drawers, glass display cases, shelves, storage trays and shoe racks. The bench version is practical and decorative at the same time, providing a comfortable yet elegant solution to enjoy moments of relaxation, immersed in a warm and refined atmosphere.



Island up modulo con panca in tessuto Zea 22. Struttura materico Noce Dorato, frontali cassetto laccato opaco Seta, vassoi in pelle sintetica Elephant, top vetro Trasparente Argento. / Island up module with Zea 22 fabric bench. Noce Dorato materico structure, Seta matt lacquered drawer fronts, Elephant synthetic leather trays, Trasparente Argento glass top.



1 — Island up modulo doppio materico Larice Tortora, frontali cassetto Miro vetro Trasparente Piombo con cornice Canna di Fucile, top vetro Trasparente Argento. / Island up module in Larice Tortora materico, Rigato Piombo glass Miro drawer fronts with Canna di Fucile frame, Trasparente Argento glass top.



2 — Island up modulo doppio materico Larice Tortora, ripiani e divisorio materico Larice Tortora, top vetro Trasparente Argento. / Island up module in Larice Tortora materico with Larice Tortora materico partition and shelves, Trasparente Argento glass top.



3 — Island up modulo con panca struttura materico Borgogna, frontali cassetto pelle sintetica Talpa, top vetro Trasparente Argento. / Island up module with bench, structure in Borgogna materico, Talpa synthetic leather drawer fronts, Trasparente Argento glass top.



4 — Island up modulo con panca in tessuto Dalia 03. Struttura materico Borgogna, frontali cassetto pelle sintetica Talpa, top vetro Trasparente Argento. / Island up module with bench in Aries 05 fabric. Borgogna materico structure, Talpa synthetic leather drawer fronts, Trasparente Argento glass top.



## Amalfi by CRS Pianca

### Battente / Hinged door

P 42.3 - 59 cm  
H 238.5 - 257.7 - 289.7 cm  
Su misura  
D 16.65" - 23.23"  
H 93.90" - 101.46" - 114.06"  
Made to measure

L 47.8 cm W 18.82"	L 57.8 cm W 22.76"	L 67.8 cm W 26.69"	L 97.8 cm W 38.50"	L 117.8 cm W 46.38"	L 137.8 cm W 54.25"	L 137.8 cm W 54.25"	L 137.8 cm W 54.25"	L 46.1 cm W 18.15"	L 46.1 cm W 18.15"

\* No profondità 42.3 cm / Not available depth 16.65"

### Cardine / Cardine hinged door

P 42.3 - 59 cm  
H 238.5 - 257.7 cm  
Su misura  
D 16.65" - 23.23"  
H 93.90" - 101.46"  
Made to measure

L 47.8 cm W 18.82"	L 57.8 cm W 22.76"	L 67.8 cm W 26.69"	L 97.8 cm W 38.50"	L 117.8 cm W 46.38"	L 117.8 cm W 46.38"	L 137.8 cm W 54.25"	L 137.8 cm W 54.25"

### Scorrevole / Sliding door

P 42.3 - 59 cm  
H 238.5 - 257.7 - 289.7 cm  
Su misura  
D 16.65" - 23.23"  
H 93.90" - 101.46" - 114.06"  
Made to measure

L 67.8 cm W 26.69"	L 97.8 cm W 38.50"	L 117.8 cm W 46.38"	L 117.8 cm W 46.38"	L 137.8 cm W 54.25"	L 147.8 cm W 58.19"

\* No altezza 289.7 cm, larghezza divisa in 2 pannelli / Not available height 114.06", door divided in 2 panels

### Complanare / Flush-sliding door

P 59 cm  
H 238.5 - 257.7 cm  
Su misura  
D 23.23"  
H 93.90" - 101.46"  
Made to measure

L 206 cm W 81.10"	L 246 cm W 96.85"	L 286 cm W 112.60"	L 306 cm W 120.47"

\* Larghezza divisa in 2 pannelli / Door divided in 2 panels

### Soluzioni angolari / Corner solutions

P 42.3 - 59 cm  
H 238.5 - 257.7 - 289.7 cm  
Su misura  
D 16.65" - 23.23"  
H 93.90" - 101.46" - 114.06"  
Made to measure

Battente / Hinged door	Cardine / Cardine hinged door	Opposto / External opening

\* No profondità 42.3 cm / Not available depth 16.65"

\*\* No altezza 289.7 cm / Not available height 114.06"



# Cornice by CRS Pianca

## Battente / Hinged door

P 42.3 - 59 cm  
H 238.5 - 257.7 cm  
Su misura  
D 16.65" - 23.23"  
H 93.90" - 101.46"  
Made to measure

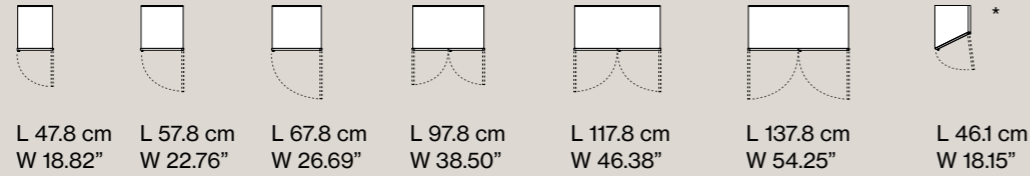

\* No profondità 42.3 cm / Not available depth 16.65"

## Scorrevole / Sliding door

P 42.3 - 59 cm  
H 238.5 - 257.7 cm  
Su misura  
D 16.65" - 23.23"  
H 93.90" - 101.46"  
Made to measure



\* Larghezza divisa in 2 pannelli / Door divided in 2 panels

## Complanare / Flush-sliding door

P 59 cm  
H 238.5 - 257.7 cm  
Su misura  
D 23.23"  
H 93.90" - 101.46"  
Made to measure

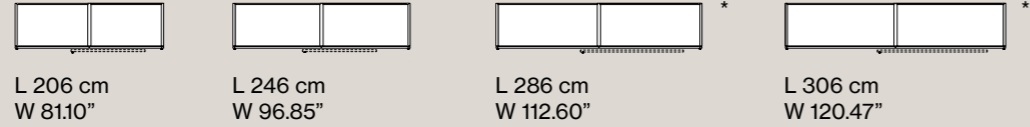

\* Larghezza divisa in 2 pannelli / Door divided in 2 panels

## Soluzioni angolari / Corner solutions

P 42.3 - 59 cm  
H 238.5 - 257.7 cm  
Su misura  
D 16.65" - 23.23"  
H 93.90" - 101.46"  
Made to measure

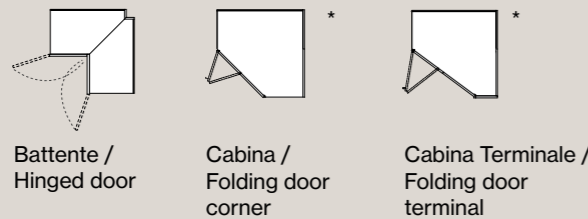

\* No profondità 42.3 cm / Not available depth 16.65"

# Crea by CRS Pianca

## Scorrevole / Sliding door

P 42.3 - 59 cm  
H 238.5 - 257.7 cm  
D 16.65" - 23.23"  
H 93.90" - 101.46"



## Complanare / Flush-sliding door

P 59 cm  
H 238.5 - 257.7 cm  
D 23.23"  
H 93.90" - 101.46"

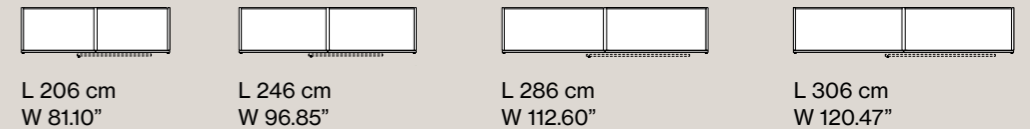

## Configurazioni anta / Door configurations

Nella stessa anta non si possono abbinare differenti colori di vetri. Le ante di tipo A e tipo B non possono essere modificate esteticamente nè rese speculari

It is not possible to combine different glass colors in the same door. Type A and type B doors cannot be reversed or modified.

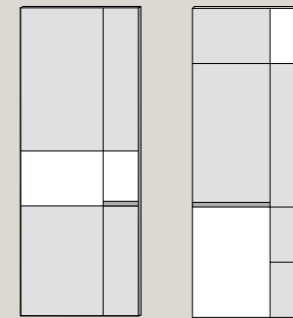

Type A

Type B

# Icona by CRS Pianca

## Battente / Hinged door

P 42.3 - 59 cm  
H 238.5 - 257.7 - 289.7 cm  
Su misura

D 16.65" - 23.23"  
H 93.90" - 101.46" - 114.06"  
Made to measure

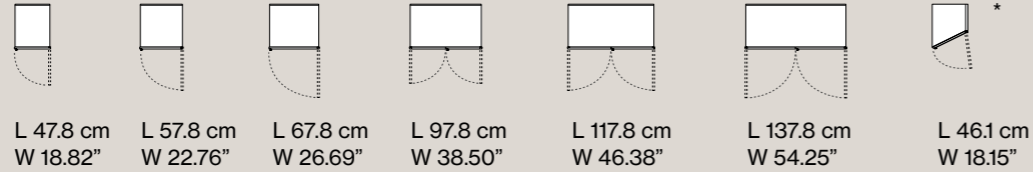

\* No profondità 42.3 cm / Not available depth 16.65"

## Scorrevole / Sliding door

P 42.3 - 59 cm  
H 238.5 - 257.7 - 289.7 cm  
Su misura

D 16.65" - 23.23"  
H 93.90" - 101.46" - 114.06"  
Made to measure



\* No altezza 289.7 cm, larghezza divisa in 2 pannelli /  
Not available height 114.06", door divided in 2 panels

## Complanare / Flush-sliding door

P 59 cm  
H 238.5 - 257.7 cm  
Su misura

D 23.23"  
H 93.90" - 101.46"  
Made to measure

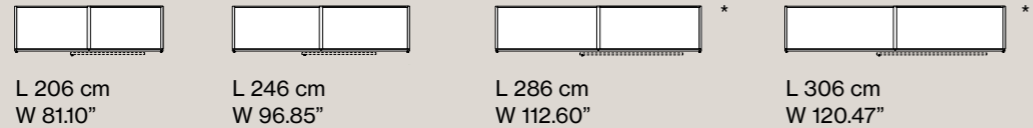

\* Larghezza divisa in 2 pannelli / Door divided in 2 panels

## Soluzioni angolari / Corner solutions

P 42.3 - 59 cm  
H 238.5 - 257.7 - 289.7 cm  
Su misura

D 16.65" - 23.23"  
H 93.90" - 101.46" - 114.06"  
Made to measure

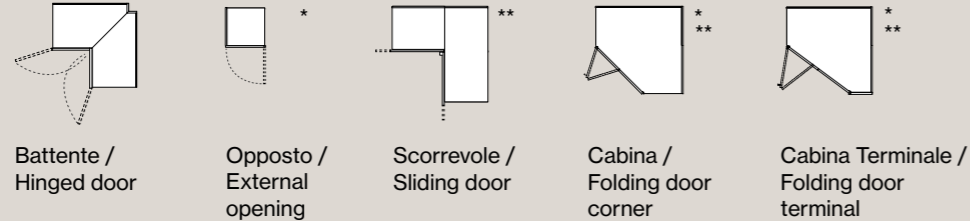

\* No profondità 42.3 cm / Not available depth 16.65"

\*\* No altezza 289.7 cm / Not available height 114.06"

# Manhattan by CRS Pianca

## Battente / Hinged door

P 42.3 - 59 cm  
H 238.5 - 257.7 cm  
Su misura

D 16.65" - 23.23"  
H 93.90" - 101.46"  
Made to measure

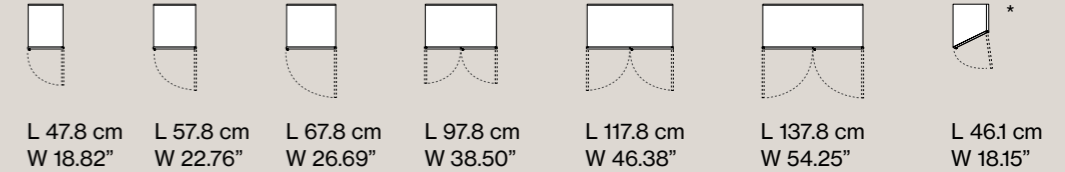

\* No profondità 42.3 cm / Not available depth 16.65"

## Scorrevole / Sliding door

P 42.3 - 59 cm  
H 238.5 - 257.7 cm  
Su misura

D 16.65" - 23.23"  
H 93.90" - 101.46"  
Made to measure



\* Non disponibile per anta vetro /  
Not available for glass door

## Soluzioni angolari / Corner solutions

P 42.3 - 59 cm  
H 238.5 - 257.7 cm  
Su misura

D 16.65" - 23.23"  
H 93.90" - 101.46"  
Made to measure

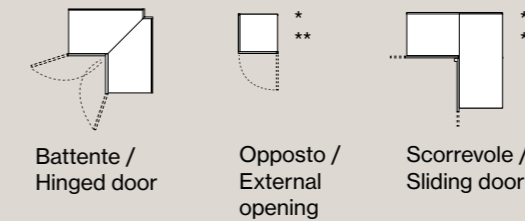

\* No profondità 42.3 cm / Not available depth 16.65"

\*\* Non disponibile per anta vetro / Not available for glass door

# Milano by CRS Pianca

## Cardine / Cardine hinged door

P 42.3 - 59 cm  
 H 238.5 - 257.7 - 289.7 cm  
 Su misura  
 D 16.65" - 23.23"  
 H 93.90" - 101.46" - 114.06"  
 Made to measure

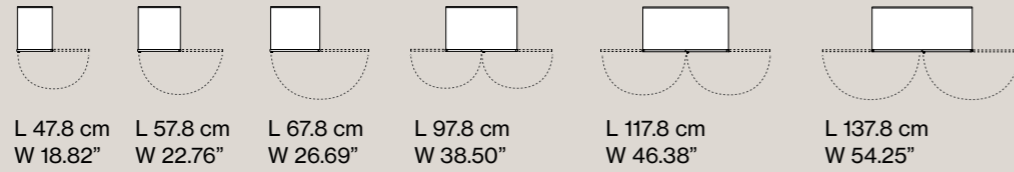

## Soluzioni angolari / Corner solutions

P 42.3 - 59 cm  
 H 238.5 - 257.7 - 289.7 cm  
 Su misura  
 D 16.65" - 23.23"  
 H 93.90" - 101.46" - 114.06"  
 Made to measure



# Murano by CRS Pianca

## Battente / Hinged door

P 42.3 - 59 cm  
 H 238.5 - 257.7  
 Su misura  
 D 16.65" - 23.23"  
 H 93.90" - 101.46"  
 Made to measure

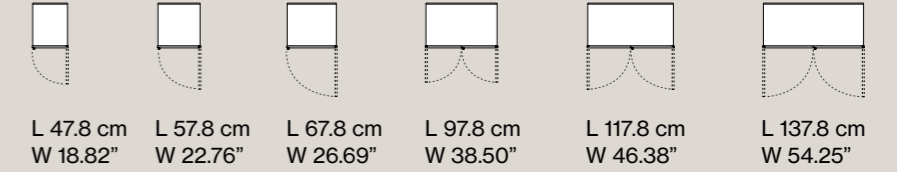

## Scorrevole / Sliding door

P 42.3 - 59 cm  
 H 238.5 - 257.7  
 Su misura  
 D 16.65" - 23.23"  
 H 93.90" - 101.46"  
 Made to measure



## Complanare / Flush-sliding door

P 59 cm  
 H 238.5 - 257.7 cm  
 Su misura  
 D 23.23"  
 H 93.90" - 101.46"  
 Made to measure



## Soluzioni angolari / Corner solutions

P 42.3 - 59 cm  
 H 238.5 - 257.7 cm  
 Su misura  
 D 16.65" - 23.23"  
 H 93.90" - 101.46"  
 Made to measure

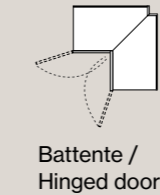

# Nastro by CRS Pianca

## Battente / Hinged door

P 42.3 - 59 cm  
H 238.5 - 257.7 - 289.7 cm  
Su misura  
D 16.65" - 23.23"  
H 93.90" - 101.46" - 114.06"  
Made to measure

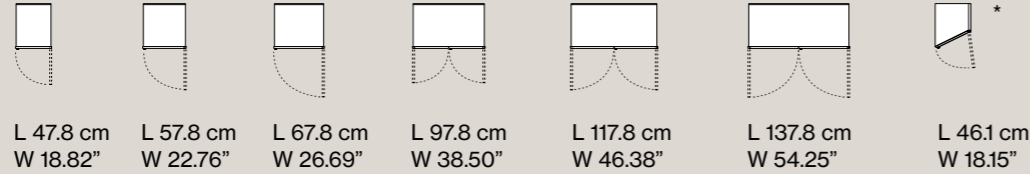

No altezza 289.7 cm per anta vetro / Not available height 114.06" for glass door

\* No profondità 42.3 cm / Not available depth 16.65"

## Scorrevole / Sliding door

P 42.3 - 59 cm  
H 238.5 - 257.7 - 289.7 cm  
Su misura  
D 16.65" - 23.23"  
H 93.90" - 101.46" - 114.06"  
Made to measure



No altezza 289.7 cm per anta vetro / Not available height 114.06" for glass door

\* No altezza 289.7 cm, larghezza divisa in 2 pannelli / Not available height 114.06", door divided in 2 panels

## Complanare / Flush-sliding door

P 59 cm  
H 238.5 - 257.7 cm  
Su misura  
D 23.23"  
H 93.90" - 101.46"  
Made to measure

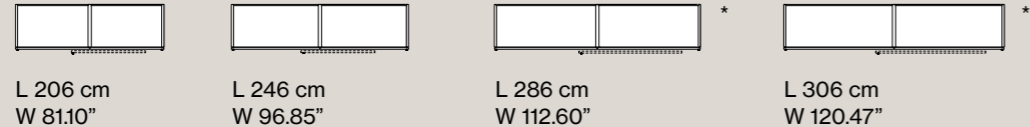

\* Larghezza divisa in 2 pannelli / Door divided in 2 panels

## Soluzioni angolari / Corner solutions

P 42.3 - 59 cm  
H 238.5 - 257.7 - 289.7 cm  
Su misura  
D 16.65" - 23.23"  
H 93.90" - 101.46" - 114.06"  
Made to measure

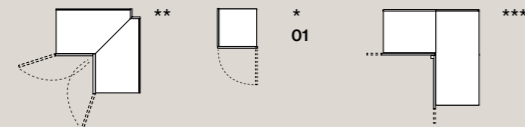

Battente / Hinged door

Opposto / External opening

Scorrevole / Sliding door

01 Non disponibile per anta vetro / Not available for glass door

\* No profondità 42.3 cm / Not available depth 16.65"

\*\* No altezza 289.7 cm per anta vetro / Not available height 114.06" for glass door

\*\*\*No altezza 289.7 cm / Not available height 114.06"

# Plana by CRS Pianca

## Battente / Hinged door

P 42.3 - 59 cm  
H 238.5 - 257.7 - 289.7 cm  
Su misura  
D 16.65" - 23.23"  
H 93.90" - 101.46" - 114.06"  
Made to measure

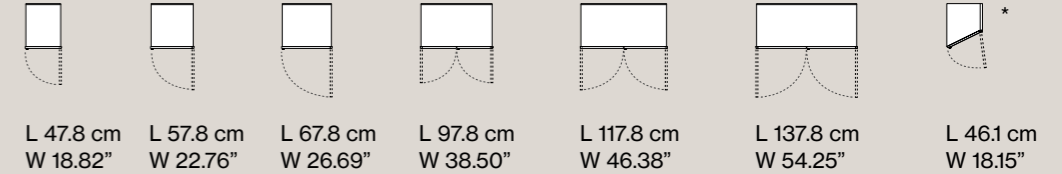

\* No profondità 42.3 cm / Not available depth 16.65"

## Cardine / Cardine hinged door

P 42.3 - 59 cm  
H 238.5 - 257.7 cm  
Su misura  
D 16.65" - 23.23"  
H 93.90" - 101.46"  
Made to measure

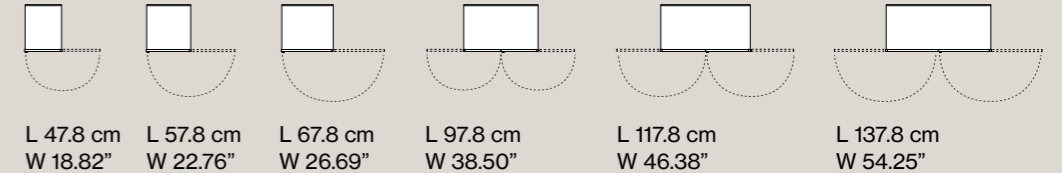

## Scorrevole / Sliding door

P 42.3 - 59 cm  
H 238.5 - 257.7 - 289.7 cm  
Su misura  
D 16.65" - 23.23"  
H 93.90" - 101.46" - 114.06"  
Made to measure

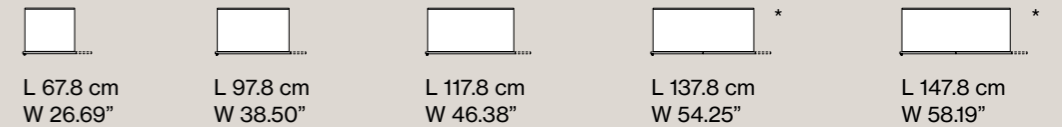

\* No altezza 289.7 cm, larghezza divisa in 2 pannelli / Not available height 114.06", door divided in 2 panels

## Complanare / Flush-sliding door

P 59 cm  
H 238.5 - 257.7 cm  
Su misura  
D 23.23"  
H 93.90" - 101.46"  
Made to measure

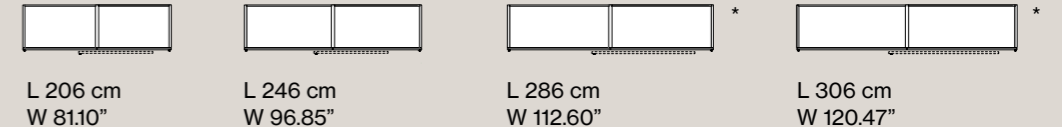

\* Larghezza divisa in 2 pannelli / Door divided in 2 panels

## Soluzioni angolari / Corner solutions

P 42.3 - 59 cm  
H 238.5 - 257.7 - 289.7 cm  
Su misura  
D 16.65" - 23.23"  
H 93.90" - 101.46" - 114.06"  
Made to measure

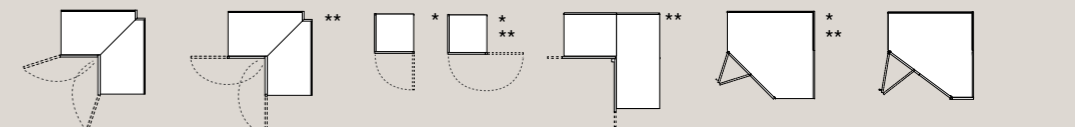

Battente / Hinged door

Cardine / Cardine hinged door

Opposto / External opening

Scorrevole / Sliding door

Cabina / Folding door corner

Cabina Terminale / Folding door terminal

\* No profondità 42.3 cm / Not available depth 16.65"

\*\* No altezza 289.7 cm / Not available height 114.06"

# Raggio by CRS Pianca

## Battente / Hinged door

P 42.3 - 59 cm  
H 238.5 - 257.7 cm  
Su misura

D 16.65 - 23.23"  
H 93.90" - 101.46"  
Made to measure

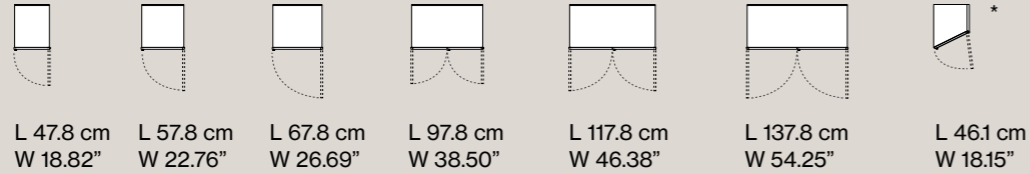

\* No profondità 42.3 cm / Not available depth 16.65"

## Scorrevole / Sliding door

P 42.3 - 59 cm  
H 238.5 - 257.7 cm  
Su misura

D 16.65 - 23.23"  
H 93.90" - 101.46"  
Made to measure

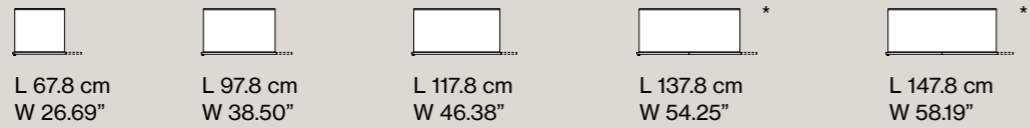

\* Larghezza divisa in 2 pannelli / Door divided in 2 panels

## Complanare / Flush-sliding door

P 59 cm  
H 238.5 - 257.7 cm  
Su misura

D 23.23"  
H 93.90" - 101.46"  
Made to measure

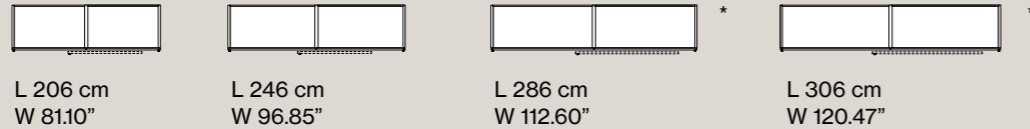

\* Larghezza divisa in 2 pannelli / Door divided in 2 panels

## Soluzioni angolari / Corner solutions

P 42.3 - 59 cm  
H 238.5 - 257.7 cm  
Su misura

D 16.65 - 23.23"  
H 93.90" - 101.46"  
Made to measure

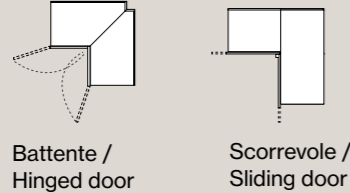

# Tratto by CRS Pianca

## Battente / Hinged door

P 42.3 - 59 cm  
H 238.5 - 257.7 cm  
Su misura

D 16.65" - 23.23"  
H 93.90" - 101.46"  
Made to measure

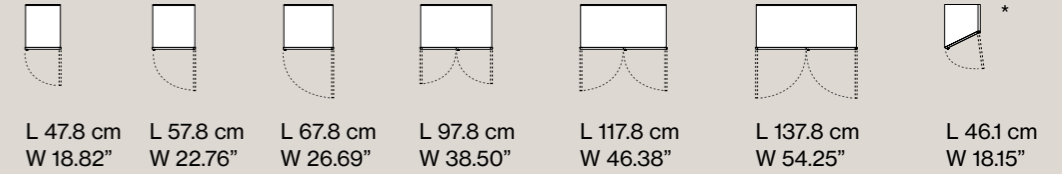

\* No profondità 42.3 cm / Not available depth 16.65"

## Scorrevole / Sliding door

P 42.3 - 59 cm  
H 238.5 - 257.7 cm  
Su misura

D 16.65" - 23.23"  
H 93.90" - 101.46"  
Made to measure

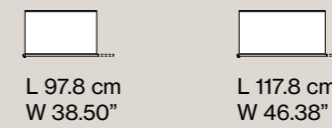

## Soluzioni angolari / Corner solutions

P 42.3 - 59 cm  
H 238.5 - 257.7 cm  
Su misura

D 16.65" - 23.23"  
H 93.90" - 101.46"  
Made to measure

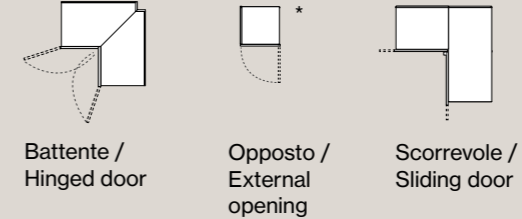

\* No profondità 42.3 cm / Not available depth 16.65"

# Verona by Calvi Brambilla

## Battente / Hinged door

P 42.3 - 59 cm  
H 238.5 - 257.7 cm  
Su misura  
D 16.65" - 23.23"  
H 93.90" - 101.46"  
Made to measure

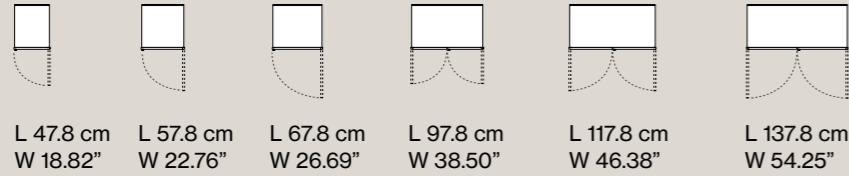

\* No profondità 42.3 cm / Not available depth 16.65"

## Complanare / Flush-sliding door

P 59 cm  
H 238.5 - 257.7 cm  
Su misura  
D 23.23"  
H 93.90" - 101.46"  
Made to measure

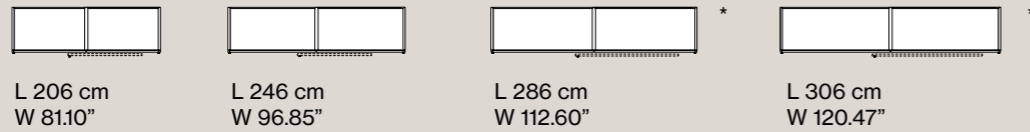

\* Larghezza divisa in 2 pannelli / Door divided in 2 panels

## Soluzioni angolari / Corner solutions

P 42.3 - 59 cm  
H 238.5 - 257.7 cm  
Su misura  
D 16.65" - 23.23"  
H 93.90" - 101.46"  
Made to measure

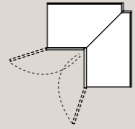

Battente / Hinged door

## Configurazioni anta / Door configurations

Tipo A-B:  
Battente /  
Type A-B:  
Hinged door

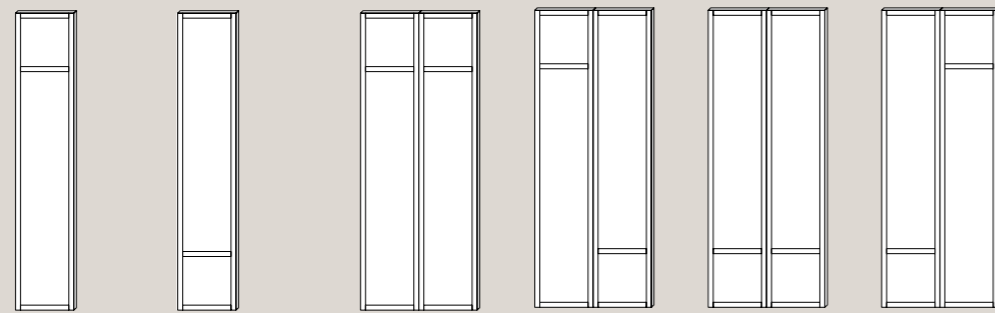

Type A

Type B

Type C

Type D

Type E

Type F

Tipo C-D-E-F:  
Complanare /  
Type C-D-E-F:  
Flush-sliding door

# Anta TV / TV Door by CRS Pianca

## Scorrevole / Sliding door

P 42.3 - 59 cm  
H 238.5 - 257.7 cm  
D 16.65" - 23.23"  
H 93.90" - 101.46"

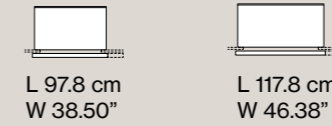

## Abbinamenti / Configurations

I moduli anta TV sono abbinabili ai moduli armadio scorrevole esclusivamente per i seguenti modelli: Amalfi, Cornice, Icona, Manhattan, Nastro, Plana, Raggio, Tratto / The TV door modules can be combined with the sliding wardrobe doors for the following models only: Amalfi, Cornice, Icona, Manhattan, Nastro, Plana, Raggio, Tratto.

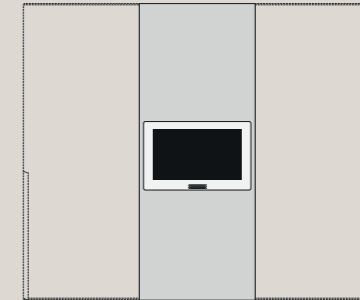

# Home Office by CRS Pianca

## Amalfi, Plana, Milano Cardine / Cardine hinged door

P 59 - 42.3 cm  
H 238.5 - 257.7 cm  
D 23.23" - 16.65"  
H 93.90" - 101.46"

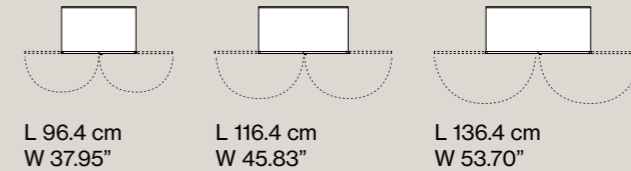

## Attrezzabilità / Accessories

Moduli a giorno /  
Open Modules

Mensole Sp 3 - 10 cm /  
Shelves Th. 1.18", 3.94"

Divisori verticali /  
Vertical partitions

Scrivania Ala / Ala Desk  
Ala / Ala Desk

Luci led con interruttore touch /  
LED lights with touch switch

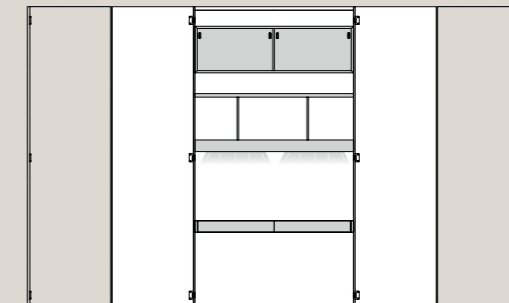

## Finiture interne armadi e cabine / Wardrobes and walk-in closet internal finishes

Tutte le finiture interne sono applicabili  
a: Base, Cappello, Ripiani, Interno  
Fianchi, Schienali e Divisori.

All internal finishes are available for:  
Base, Top, Shelves, Internal Sides,  
Backs and Partitions.

1 – Materico Bon Ton  
2 – Duna laccato opaco  
nei colori della collezione  
/ Duna matt lacquered  
in all the colors of our  
collection



3 – Materico Perlage  
Conchiglia  
4 – Materico Perlage  
Terra



5 – Materico Noce  
Dorato  
6 – Materico Borgogna



7 – Materico Larice  
Tortora



Ripiani / Shelves

- 1 — Ripiano legno /  
Wooden shelf
- 2 — Ripiano legno con  
inserto in pelle sintetica  
/ Wooden shelf synthetic  
leather insert



- 3 — Ripiano in vetro con  
telaio Manganese con  
luce led / Glass shelf with  
Manganese frame and  
LED light
- 4 — Ripiano in vetro con  
telaio in legno con luce  
led / Glass shelf with  
wooden frame and LED  
light



- 5 — Ripiano Vetro / Glass  
shelf



Divisori interni / Internal partitions

- 1 — Divisori a tutta  
altezza / Full height  
partitions
- 2 — Divisori da base /  
Under shelf partitions



- 3 — Raster / Cubbies

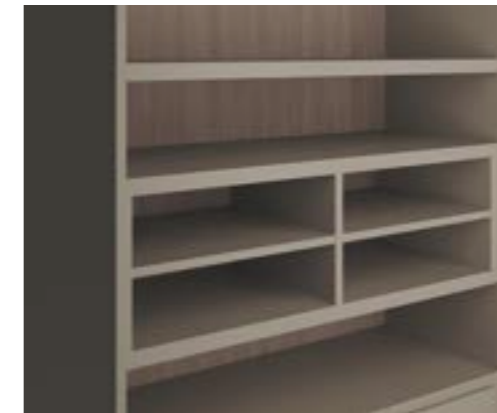



Cassettiere / Drawer units

- 1 — A terra / Floor sitting
- 2 — Pensili / Suspended



- 3 — Con elementi a T con vano superiore / T elements with open upper compartment
- 4 — Con elementi a T di pari altezza / T elements flush with a unit top



Top cassettiere / Drawer units

- 1 — Legno / Wooden
- 2 — Pelle sintetica / Synthetic leather



- 3 — Vetro con cornice legno / Glass top with wooden frame
- 4 — Vetro con cornice metallo e luce Led / Glass top with metal frame and LED light



Cassettiere standard / Drawer fronts

- 1 — Legno / Wood
- 2 — Vetro / Glass



- 3 — Miro frontale vetro con cornice metallo / Miro glass front with metal frame
- 4 — Pelle sintetica / Synthetic leather



Per NUDESIGN aggiungere serigrafia nella parte evidenziata. Come riferimento prendere parte sottostante

Cassettiere metallo / Metal drawer fronts

- 1 — Legno / Wood
- 2 — Vetro / Glass



- 3 — Miro frontale vetro con cornice metallo / Miro glass front with metal frame
- 4 — Pelle sintetica / Synthetic leather



**Appenderia / Hangers**

- 1 — Servetto estraibile / Pull-down rod
- 2 — Asta appendiabiti di serie / Standard hanging rod
- 3 — Asta appendiabiti Lux / Lux hanging rod



- 4 — Portacinture, portacravatte da applicare al fianco, divisorio / Belt, tie holder fixed on the side, partition
- 5 — Portacravatte fisso / Fixed tie holder



- 6 — Pomolo estraibile incassato nel ripiano / Pull-out knob recessed inside the shelf
- 7 — Asta appendiabiti estraibile / Pull-out hanging rod



**Ripiani portascarpe / Shoe shelves**

1 — Ripiano portascarpe  
legno / Wooden shoe  
shelf



2 — Ripiano portascarpe  
con battitacco in metallo  
/ Shoe shelf with metal  
shoe stopper



**Purificatore / Air Purifier**

1 — Purificatore d'aria /  
Air purifier



**Cassettiere con ruote / Drawer units on castors**

1 — Cassettiere  
autoportanti con ruote /  
Drawer unit on castors



Cassetti attrezzati con telai estraibili / Drawers equipped with pull-out frames

I telai estraibili vengono fissati al frontale del cassetto in sostituzione del girocassetto / Pull-out trays are fixed to the drawer front replacing the regular drawer frame

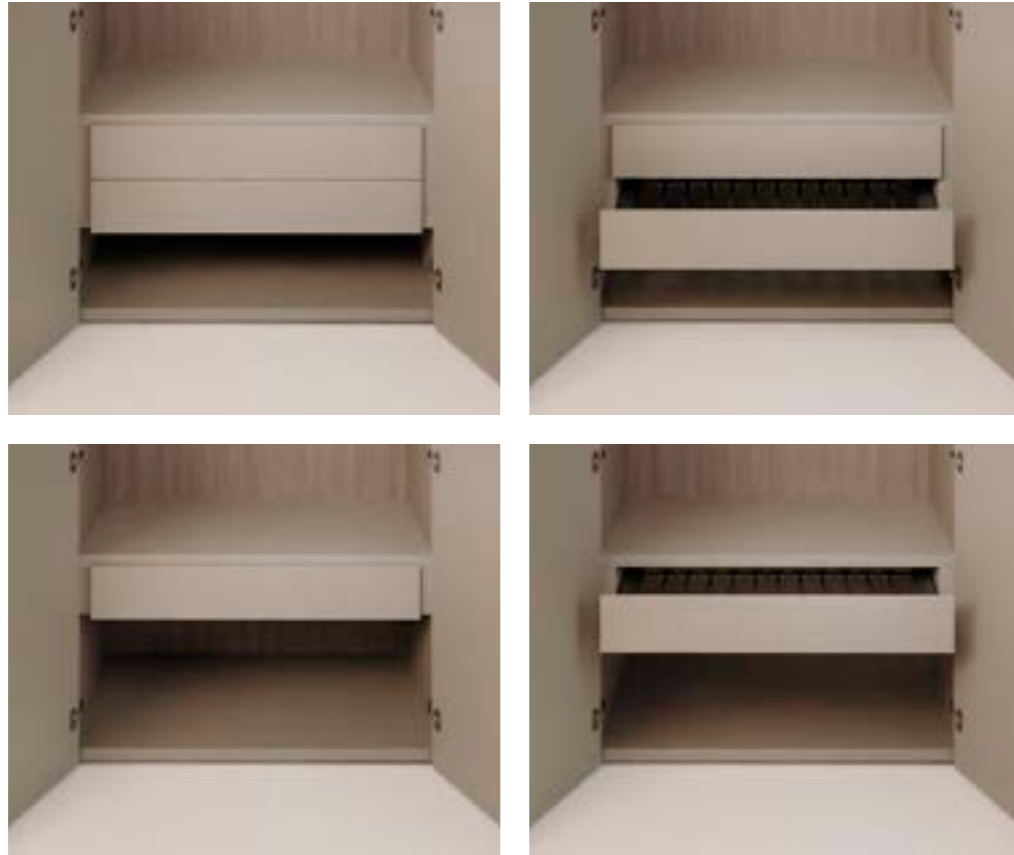

Telai estraibili e accessori / Pull-out frames and accessories

1 – Piano legno /  
Wooden shelf  
2 – Piano vetro /  
Glass shelf



3 – Portapantaloni /  
Trousers rack  
4 – Scarpiera in metallo /  
Metal shoe rack



5 – Sacche portabiancheria in tessuto trapuntato /  
Hampers in tufted fabric  
6 – Sacche portabiancheria in tessuto trapuntato con frontale /  
Hampers in tufted fabric with wooden front



Accessori / Accessories

1 — Anello grande portasciarpe, foulard e borse / Large ring hanger for scarves and bags  
 Anello piccolo portacravatte o cinture / Small ring hanger for ties and belts  
 Bastone prendiabiti / Rod

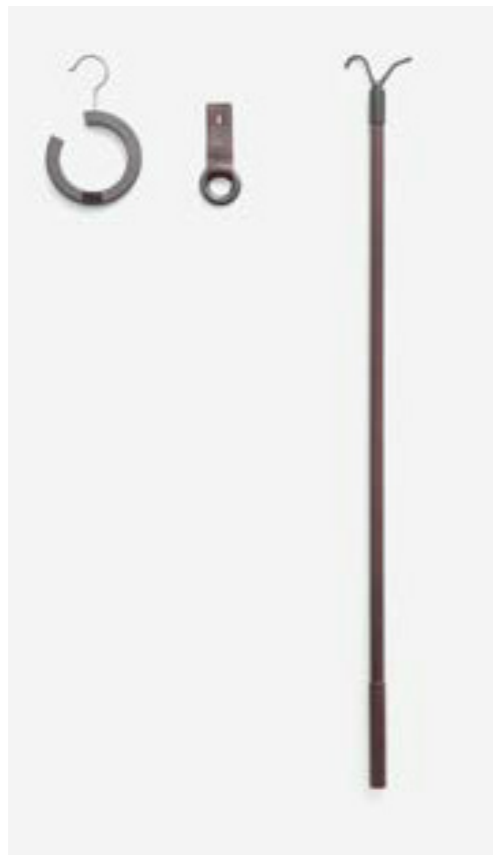

2 — Gruccia capospalla uomo con portapantaloni / Man hanger with trouser hanger  
 Gruccia portapantaloni / Trouser hanger



3 — Gruccia capospalla donna con portagonna / Woman hanger with skirt hanger  
 Gruccia portagonne / Skirt hanger



4 — Scatole con coperchio / Boxes with lid  
 5 — Fondo per cassetti / Drawer mat



6 — Vassoio e vassoio con griglia portafoulard, cravatte, cinture / Standard tray and basic tray with scarves, ties and belt dividers  
 7 — Svuotatasche: Possono essere inseriti nei cassetti e vassoi / Valet trays: they can be inserted in drawers and pull-out trays



**Specchi / Mirrors**

1 — Specchio estraibile ed orientabile applicabile al fianco scorrevole o complanare / Pull-out and swiveling mirror attached to the side of sliding and flush sliding door wardrobes  
 2 — Specchio orientabile applicabile al fianco / Swiveling mirror attached to the side



3 — Specchio fisso applicabile all'anta battente / Fixed mirror attached to the back of hinged doors  
 4 — Specchio fianco di finitura / Mirror finishing side



**Illuminazione / Lighting**

1 — Luci led verticali per moduli armadio / Vertical LED lights for wardrobe modules  
 2 — Luci led orizzontali per ripiani e cappelli ad incasso / Horizontal recessed LED lights for shelves and tops  
 3 — Ripiano con luce, inserita all'interno del telaio / Shelf with LED light inserted in the frame



Allestimenti interni / Interior configurations



1 Asta appendiabiti /  
Hanging rod  
6 Ripiani legno /  
Wooden shelves  
1 Divisorio interno /  
Internal partition  
1 Portapantaloni estraibile  
/ Pull-out trouser rack

2 Aste appendiabiti /  
Hanging rods  
1 Ripiano legno /  
Wooden shelf  
2 Ripiani legno estraibili /  
Pull-out wooden shelves  
1 Cassettiera a terra /  
Floor sitting drawer unit  
1 Divisorio interno /  
Internal partition

2 Aste appendiabiti /  
Hanging rods  
2 Ripiani legno /  
Wooden shelves  
1 Cassettiera a terra /  
Floor sitting drawer unit  
1 Divisorio interno /  
Internal partition

2 Ripiani legno /  
Wooden shelves  
1 Cassettiera pensile /  
Suspended drawer unit  
1 Cassettiera a terra /  
Floor sitting drawer unit



1 Asta appendiabiti /  
Hanging rod  
1 Ripiani legno /  
Wooden shelf  
1 Cassettiera a terra /  
Floor-sitting drawer unit  
1 Raster legno /  
Wooden cubby

2 Aste appendiabiti /  
Hanging rods  
1 Ripiani legno /  
Wooden shelf  
1 Cassettiera a terra /  
Floor-sitting drawer unit  
1 Raster legno /  
Wooden cubby  
1 Divisorio interno /  
Internal partition

1 Asta appendiabiti /  
Hanging rod  
4 Ripiani legno /  
Wooden shelves  
3 Ripiani portascarpe /  
Shoe rack shelves  
1 Cassettiera a terra /  
Floor-sitting drawer unit  
1 Divisorio interno /  
Internal partition

1 Asta appendiabiti /  
Hanging rod  
1 Ripiano legno /  
Wooden shelf  
1 Cassettiera a terra /  
Floor sitting drawer unit



- 1 – Modulo stagionale / Seasonal module
- 2 – Modulo per elettrodomestici / Module for household appliances



- 3 – Modulo cassettera esterna / External drawer module
- 4 – Modulo con vano a giorno / Module with open element



- 5 — Modulo a ponte / Bridge module
- 6 — Modulo Home office / Home office Module



- 7 — Modulo TV / TV module
- 8 — Anta TV scorrevole / TV sliding door



- 9 — Angolo battente / Hinged corner module
- 10 — Angolo scorrevole / Sliding corner module



- 11 — Cabina angolare a soffietto / Folding door corner dressing closet
- 12 — Cabina terminale a soffietto / Folding door terminal dressing closet



13 — Modulo terminale a giorno / Open terminal module

14 — Modulo terminale a giorno con asta appendiabiti / Open terminal module with hanging rod



15 — Modulo Terminale a scrigno / Module with L-shaped opening

16 — Angolo battente opposto / External hinged corner module



17 — Modulo sovrapporta / Over door module

18 — Pannelli per modulo centrostanza / Panels for all-side finished modules



19 — Modulo estraibile a ripiani / Pull-out module with shelves



## Sipario by CRS Pianca

Con telaio/  
With frame

I moduli cabina Sipario possono essere allestiti con tutti gli accessori interni previsti per i moduli armadio pag. 210 / Sipario walk-in closet modules can be equipped with all internal accessories available for wardrobes on page 210

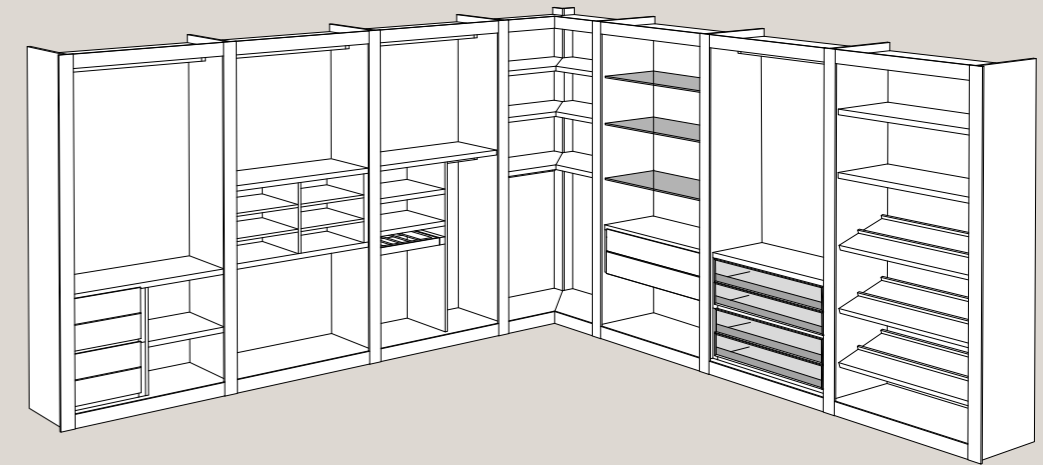

- 1 – Moduli / Modules
- 2 – Divisori / Partitions
- 3 – Angolo / Corner

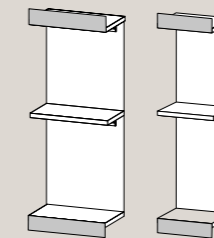

Dimensioni / Dimensions  
L 47.8 - 57.8 - 67.8 - 97.8  
117.8 - 137.8 - 147.8 cm  
H 238.5 - 257.7 - 289.7 cm  
Su misura  
W 18.81" - 22.76" - 26.69"  
38.50" - 46.38" - 54.25"  
58.19"  
H 93.90" - 101.46" - 114.06"  
Made to measure



Dimensioni / Dimensions  
L 2.2 cm  
H 238.5 - 257.7 - 289.7 cm  
Su misura  
W 0.87"  
H 93.90" - 101.46" - 114.06"  
Made to measure

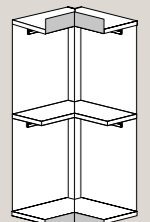

Dimensioni / Dimensions  
L 94 x 94 cm, P 42.3 cm  
110.7 x 110.7, P 59 cm  
H 238.5 - 257.7 - 289.7 cm  
Su misura  
W 37.01"x 37.01", D 16.65"  
W 43.58"x 43.58", D 23.23"  
H 93.90" - 101.46" - 114.06"  
Made to measure

# Sipario by CRS Pianca

Senza telaio/  
Without frame

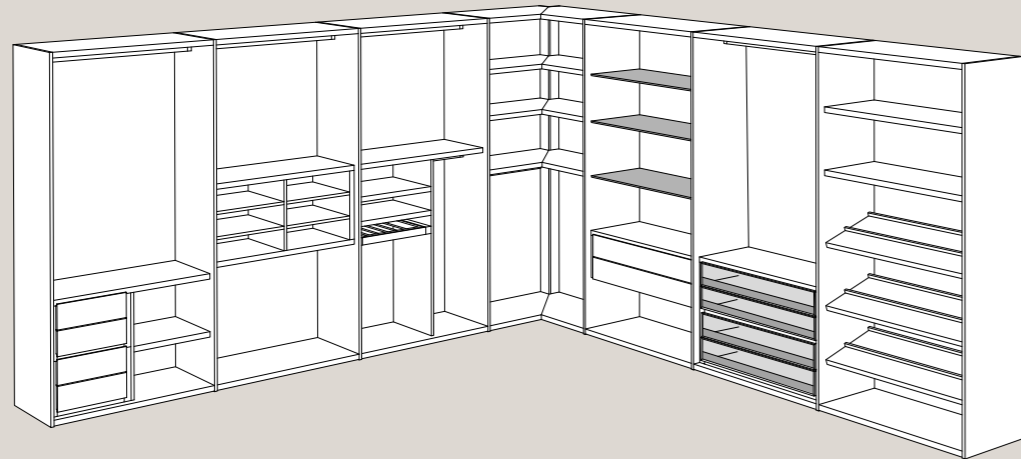

- 1 – Moduli / Modules
- 2 – Divisori / Partitions
- 3 – Angolo / Corner

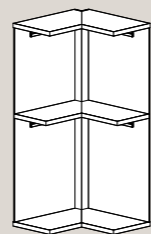
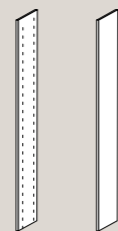
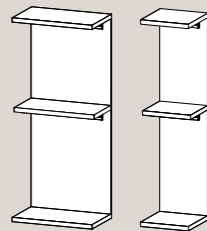

Dimensioni / Dimensions  
L 47.8 - 57.8 - 67.8 - 97.8  
117.8 - 137.8 - 147.8 cm  
H 238.5 - 257.7 - 289.7 cm  
Su misura  
W 18.81" - 22.76" - 26.69"  
38.50" - 46.38" - 54.25"  
58.19"  
H 93.90" - 101.46" - 114.06"  
Made to measure

Dimensioni / Dimensions  
L 2.2 cm  
H 238.5 - 257.7 - 289.7 cm  
Su misura  
W 0.87"  
H 93.90" - 101.46" - 114.06"  
Made to measure

Dimensioni / Dimensions  
L 94 x 94 cm, P 42.3 cm  
110.7 x 110.7, P 59 cm  
H 238.5 - 257.7 - 289.7 cm  
Su misura  
W 37.01"x 37.01", D 16.65"  
W 43.58"x 43.58", D 23.23"  
H 93.90" - 101.46" - 114.06"  
Made to measure

# Attrezzabilità / Equipability

I moduli cabina Sipario possono essere allestiti con tutti gli accessori interni previsti per i moduli armadio pag. 204. Possono essere abbinati a tutti i moduli di ante della collezione.

Sipario walk-in closet modules can be equipped with all internal accessories available for wardrobes on page 204. They can be combined with all the doors of the collection.

# Anteprima by CRS Pianca

Con schienali /  
With back panels

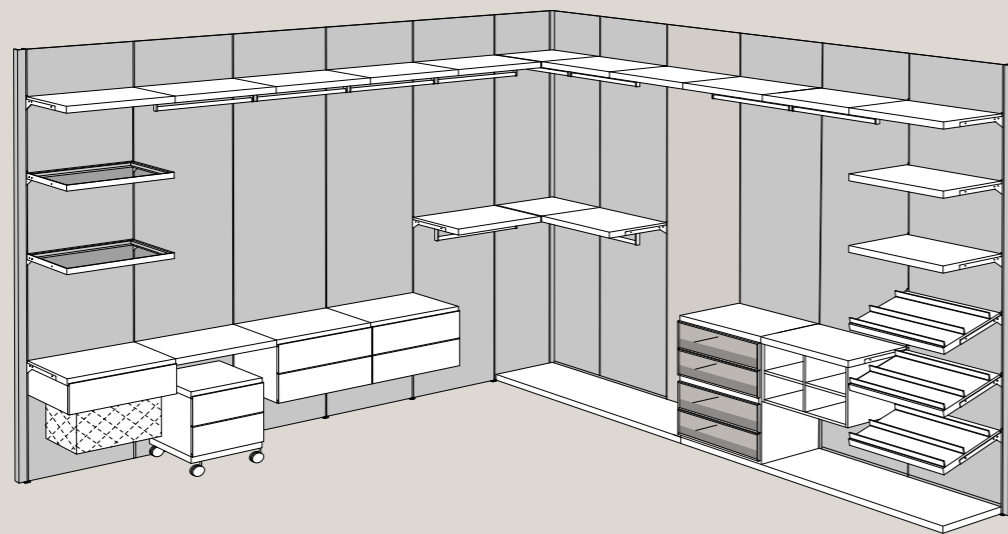

1 — Schienali / Back panels  
2 — Cornici ad L, lineari, ad angolo / L shaped, straight, corner frames

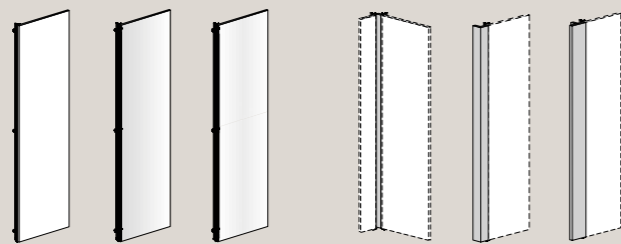

Dimensioni / Dimensions  
L 50 - 70 - 90 - 110 cm  
H 238.5 - 257.7 - 289.7 cm  
W 19.69" - 27.56" - 35.43" - 43.31"  
H 93.90" - 101.46" - 114.06"

Dimensioni / Dimensions  
L 6 cm da 5 a 21 cm - 10x10 cm  
H 238.5 - 257.7 - 289.7 cm  
W 2.36" from 1.97" to 8.27" - 3.94"x3.94  
H 93.90" - 101.46" - 114.06"

## Ripiani e pedane con schienale cabine / Shelves and bases with back panel

1 — Ripiano con staffe a vista / Shelf with visible supports  
2 — Ripiano con staffe a scomparsa / Shelf with invisible supports



3 — Ripiano portascarpe con staffe a vista / Shoe shelf with visible supports  
4 — Ripiano portascarpe con staffe a scomparsa / Shoe shelf with invisible supports



5 — Ripiano in vetro Trasparente Piombo con telaio / Trasparente Piombo glass shelf with frame  
6 — Pedane / Bases



# Anteprima by CRS Pianca

Senza schienali /  
Without panels

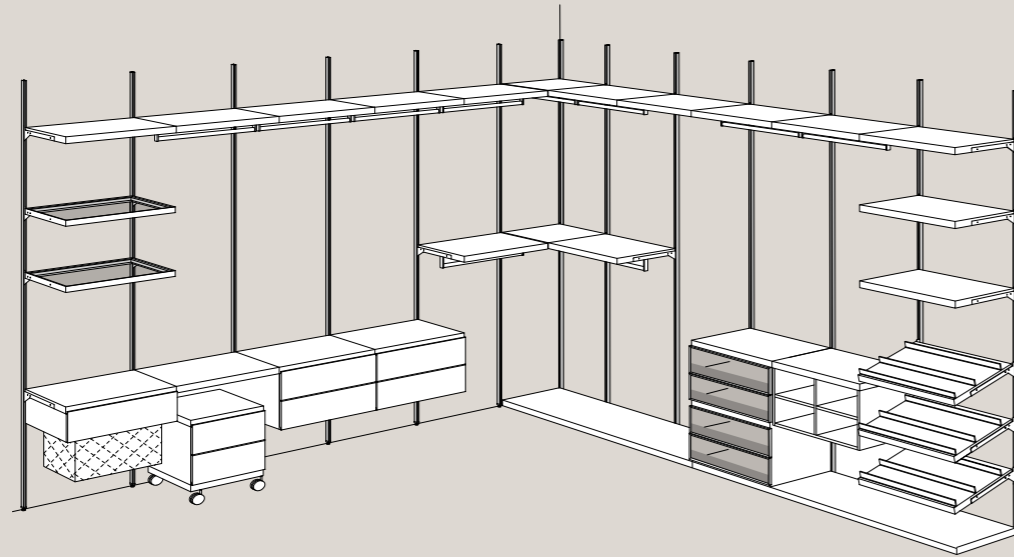

1 – Montanti /  
Vertical supports



Dimensioni / Dimensions  
H 238.5 - 257.7 - 289.7 cm  
H 93.90" - 101.46" - 114.06"

## Ripiani e pedane senza schienale cabine / Shelves and bases without back panel

1 – Ripiano con staffe a vista / Shelf with visible supports  
2 – Ripiano con staffe a scomparsa / Shelf with invisible supports



3 – Ripiano portascarpe con staffe a vista / Shoe shelf with visible supports  
4 – Ripiano portascarpe con staffe a scomparsa / Shoe shelf with invisible supports

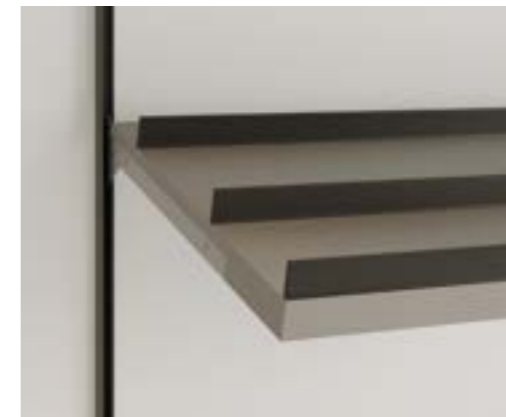

5 – Ripiano in vetro  
Trasparente Piombo con telaio / Trasparente  
Piombo glass shelf with frame  
6 – Pedane / Bases



Schienali cabine / Walk-in closet back panels

1 – Duna laccato opaco /  
Duna Matt lacquered  
2 – Materico interno /  
Materico Interior



3 – Vetro retroilluminato /  
Backlit glass  
4 – Vetro laccato Opaco  
o Lucido / Matt or Glossy  
Lacquered glass



5 – Specchio / Mirror  
6 – Materico marmo  
opaco o lucido / Matt or  
glossy marble Materico



7 – Pelle sintetica /  
Synthetic leather



Cassettiere cabine / Drawer units

1 – Cassettiera  
autoportante / Floor  
sitting drawer unit  
2 – Cassettiera  
autoportante con ruote /  
Free standing drawer unit  
on castors



3 – Cassettiera pensile /  
Suspended drawer unit  
4 – Cassettiera  
sottopiano / Under shelf  
drawer unit





Frontali cassetti cabine / Drawer fronts

- 1 – Legno / Wooden
- 2 – Vetro / Glass



- 3 – Miro frontale vetro con cornice metallo / Miro glass front with metal frame
- 4 – Pelle sintetica / Synthetic leather



Telai estraibili e accessori cabine / Pull-out frames and accessories

- 1 – Portapantaloni / Trousers rack
- 2 – Scarpiera in metallo / Metal shoe rack



- 3 – Sacche portabiancheria in tessuto trapuntato / Hampers in tufted fabric
- 4 – Sacche portabiancheria in tessuto trapuntato con frontale / Hampers in tufted fabric with wooden front



# Teatro by CRS Pianca

## A parete / Wall compositions

I moduli devono essere sempre compresi tra divisori aperti oppure tra fianchi terminali aperti o chiusi. È obbligatorio almeno un ripiano per modulo / All modules must always be placed between two open partitions or between two open or closed sides. Each module must be equipped with at least one shelf

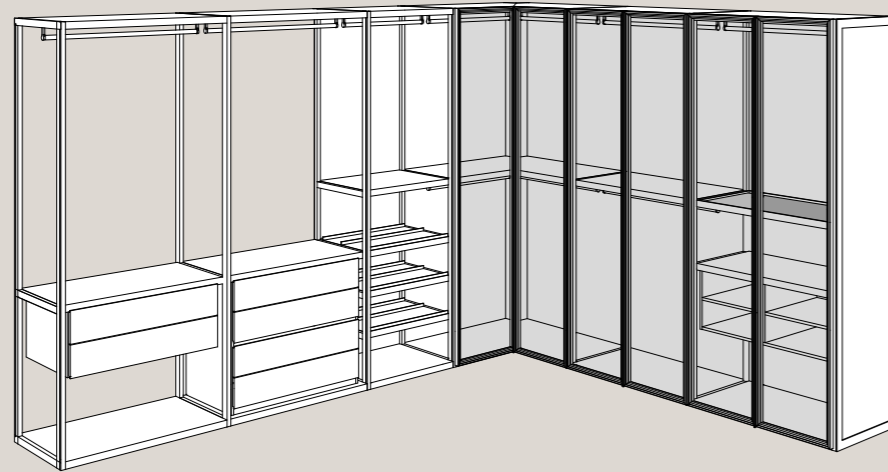

- 1 – Modulo con schiena legno / Module with wooden backpanel
- 2 – Modulo con schiena vetro / Module with glass backpanel
- 3 – Modulo senza schiena / Module without backpanel

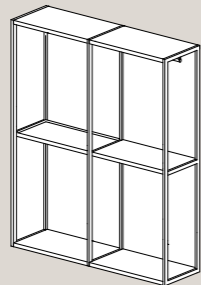

H max 289.7 cm /  
H max 114.05"

H max 257.7 con Anta  
Murano e fianco vetro /  
H max 101.46" with Murano  
door and glass side

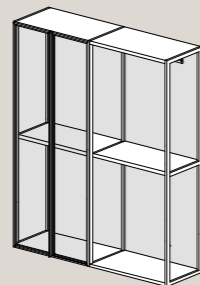

H max 257.7 cm /  
H max 101.46"

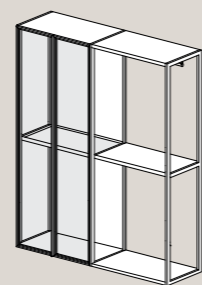

H max 289.7 cm /  
H max 114.05"

H max 257.7 con fianco  
vetro / H max 101.46"  
with glass side

## Centrostanza / Center of the room

La composizione deve prevedere moduli accostati che abbiano sempre la schiena e fianco terminale vetro o legno. Sono obbligatori almeno 2 ripiani per modulo / Any closet placed in the center of a room must be composed of at least two modules with glass or wooden back and side panel. Each module must be equipped with at least two shelves

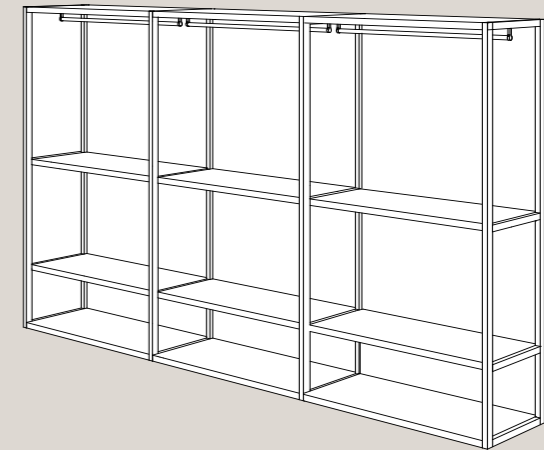

- 1 – Modulo con schiena legno / Module with wooden backpanel
- 2 – Modulo con schiena vetro / Module with glass backpanel

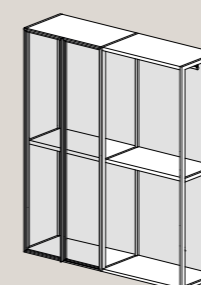

H max 238.5 cm /  
H max 93.90"

P min 57.8 cm /  
D min 22.76"

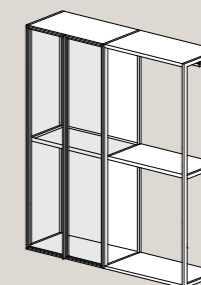

H max 238.5 cm /  
H max 93.90"

P min 57.8 cm /  
D min 22.76"

Anta Murano / Murano Door

I moduli con schiena possono essere completati da ante battenti Murano / All closets with back panel can be equipped with Murano hinged doors

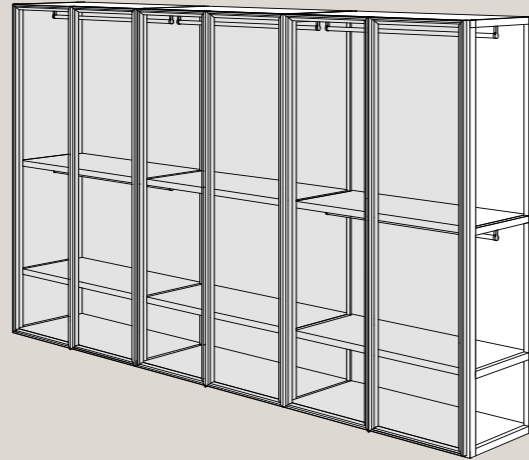

1 — Anta battente / Hinged door  
2 — Angolo / Corner

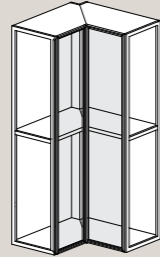
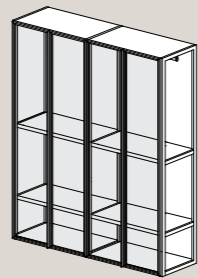

Dimensioni / Dimensions  
L 47.8 - 57.8 - 67.8 - 97.8  
117.8 - 137.8 cm  
H 238.5 - 257.7 cm  
W 18.82" - 22.76" - 26.69" -  
38.50" - 46.38" - 54.25"  
H 93.90" - 101.46"

Dimensioni / Dimensions  
L 109.4 P 57.8 cm  
L 92.7 P 41.1 cm  
H 238.5 - 257.7 cm  
W 43.07" D 22.76"  
W 36.49" D 16.18"  
H 93.90" - 101.46"

Con moduli Sipario / Combination with Sipario modules

I moduli Teatro possono essere collegati a moduli Sipario con anta battente, scorrevole, cardine e cabina senza telai / Teatro Modules can be used in combination with Sipario hinged, sliding or cardine hinged door modules as well as with Sipario walk-in closets without frames



Schiene / Backpanels

- 1 — Duna laccato opaco /  
Duna matt lacquered
- 2 — Materico interno /  
Materico Interior



- 3 — Vetro / Glass
- 4 — Materico marmo  
opaco o lucido / Matt or  
glossy marble Materico



Ripiani / Shelves

- 1 — Ripiano in Materico /  
Materico shelf
- 2 — Ripiano in Duna  
laccato opaco / Duna  
Matt lacquered shelf



- 3 — Ripiano con inserti  
in pelle sintetica / Shelf  
with synthetic leather  
insert
- 4 — Ripiano in vetro con  
telaio in metallo / Glass  
shelf with metal frame



- 5 — Ripiano portascarpe /  
Shoe shelf



**Appenderia / Hangers**

1 — Asta appendiabiti Lux  
/ Lux hanging rod  
2 — Pomolo estraibile  
incassato nel ripiano /  
Pull-out knob recessed  
inside the shelf



3 — Asta appendiabiti  
estraibile / Pull-out  
hanging rod



4 — Raster / Cubbies



**Cassettiere / Drawer units**

1 — A terra / Floor sitting  
2 — Pensili / Suspended



**Cassettiere standard / Drawer fronts**

- 1 — Legno / Wooden
- 2 — Vetro / Glass



- 3 — Miro frontale vetro con cornice metallo / Miro glass front with metal frame
- 4 — Pelle sintetica / Synthetic leather



**Cassettiere metallo / Drawer fronts**

- 1 — Legno / Wooden
- 2 — Vetro / Glass



- 3 — Miro frontale vetro con cornice metallo / Miro glass front with metal frame
- 4 — Pelle sintetica / Synthetic leather



**Cassetti attrezzati con telai estraibili / Drawers equipped with pull-out frames**

I telai estraibili vengono fissati al frontale del cassetto in sostituzione del girocassetto / Pull-out trays are fixed to the drawer front replacing the standard drawer frame



**Telai estraibili e accessori / Pull-out frames and accessories**

1 – Vassoio metallo / Metal tray  
2 – Piano vetro Trasparente Piombo / Transparente Piombo glass shelf



3 – Sacche portabiancheria in tessuto trapuntato con frontale / Hampers in tufted fabric with wooden front  
4 – Sacche portabiancheria in tessuto trapuntato / Hampers in tufted fabric with tall front panel



5 – Portapantaloni / Trousers rack



**Illuminazione / Lighting**

1 — Luci led verticali per moduli / Vertical LED lights for wardrobe modules

2 — Luci led orizzontali ad incasso / Horizontal recessed LED lights for shelves and tops

3 — Ripiano con luce / Shelf with LED light





## Island up by CRS Pianca

Il modulo può essere completato con la teca superiore in vetro, con vassoi rivestiti nelle diverse conformazioni, con telai estraibili completi di accessori (vassoio in metallo, piano in legno materico o vetro fumè trasparente) e serratura elettronica.

The Island module can be supplied with a glass top display case, with lined trays available in various configurations, with pull-out trays completed with accessories for the drawer's interior (metal tray, wood or transparent Fumé glass shelf) and the electronic lock.

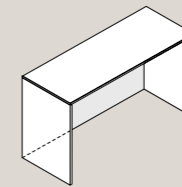

Struttura con schienale /  
Structure with back panel

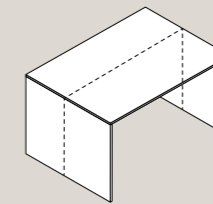

Struttura doppia H 85 cm /  
Double structure H 33.46"

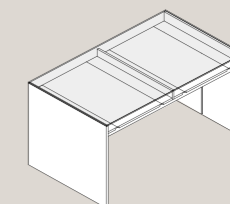

Struttura doppia H 95 cm /  
Double structure H 37.40"

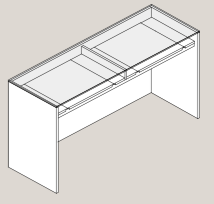

Struttura H 95 cm /  
Structure H 37.40"

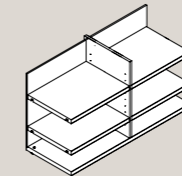

Vano con ripiani /  
Module with shelves

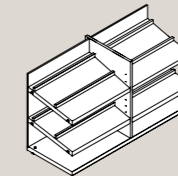

Vano con portascarpe /  
Module with shoe shelves

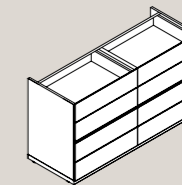

Vano con cassetti /  
Module with drawers

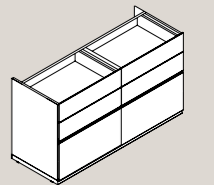

Vano con cassetto e  
cestone / Module with  
drawers and tall drawers

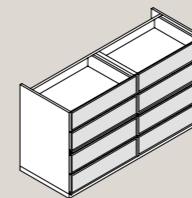

Vano con cassetti vetro  
Miro / Module with Miro  
glass drawers

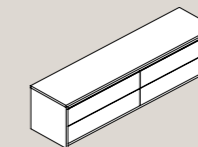

Panca con cassetti /  
Bench with drawers

## Componibilità / Modularity

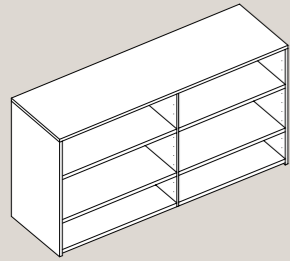

Modulo singolo H 85 cm con ripiani /  
Single module H 33.46" with shelves

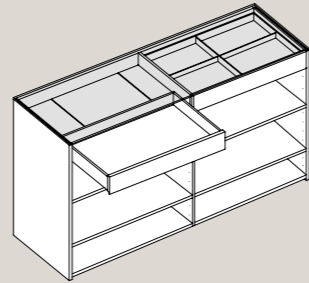

Modulo singolo H 95 cm con ripiani e cassetti /  
Single module H 37.40" with shelves and drawers

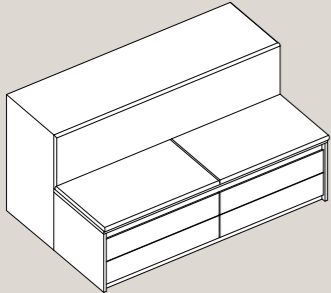

Modulo singolo H 85 cm con panca /  
Single module H 33.46" with bench

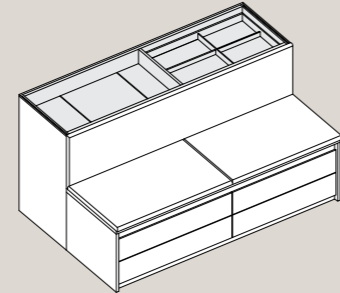

Modulo singolo H 95 cm con panca /  
Single module H 37.40" with bench

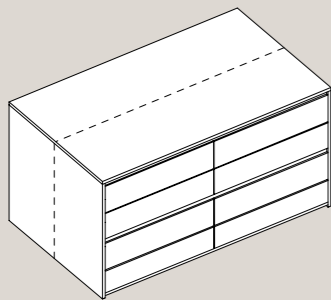

Modulo doppio H 85 cm con cassetti /  
Double module H 33.46" with drawers

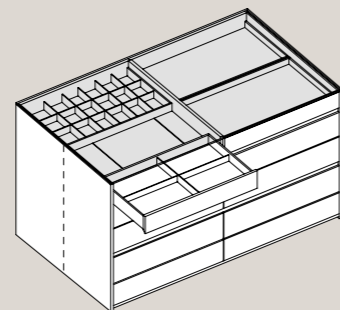

Modulo doppio H 95 cm con cassetti e top in vetro /  
Double module H 37.40" with drawers and glass top

## Accessori / Accessories

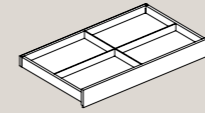

Cassetto con vassoio  
tipo A / Drawer with  
type A tray

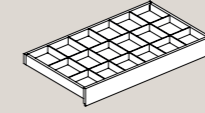

Cassetto con vassoio  
tipo B / Drawer with  
type B tray

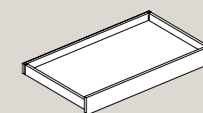

Cassetto con vassoio  
tipo C / Drawer with  
type C tray

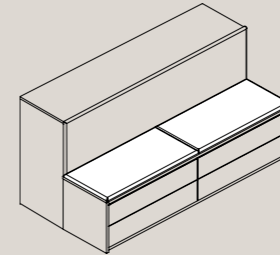

Cuscino seduta /  
Seat cushion

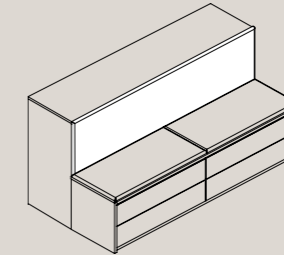

Cuscino schienale /  
Back cushion

# Vista by CRS Pianca

Il sistema di chiusura Vista si caratterizza per la totale assenza di telai e per la modularità al millimetro. Binari e ante vengono sempre realizzati su misura.

A characteristic of the Vista door system is the absence of frames and the wide modularity. Rails and doors are always made to measure.

## Binario monorotaia / Single track

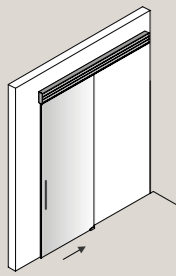

A parete / Wall mounted  
L min 135 max 600 cm  
W min 53.15" max 236.22"

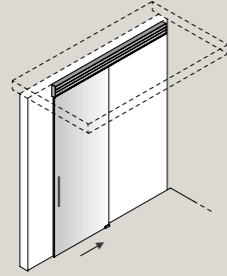

A soffitto / Ceiling mounted  
L min 135 max 600 cm  
W min 53.15" max 236.22"

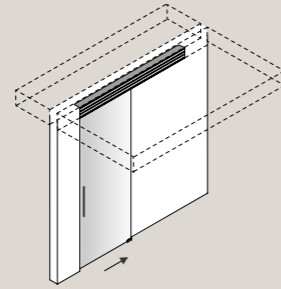

Ad incasso / Recessed  
L min 135 max 600 cm  
W min 53.15" max 236.22"

## Binario monorotaia + pannello fisso / Single track + fixed panel

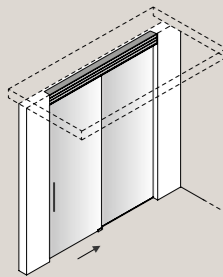

A soffitto / Ceiling mounted  
L min 138 max 600 cm  
W min 54.33" max 236.22"

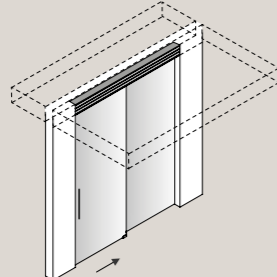

Ad incasso / Recessed  
L min 138 max 600 cm  
W min 54.33" max 236.22"

## Complementi / Complements

### Binario birotaia / Double track

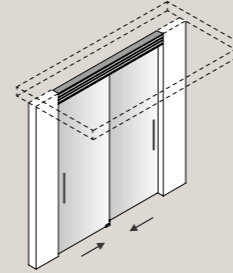

A soffitto / Ceiling mounted

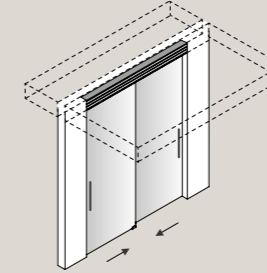

Ad incasso / Recessed

### Angolari / Corner

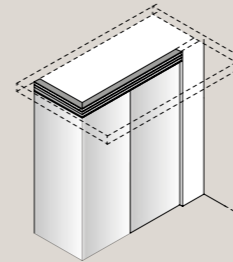

Pannello fisso soffitto / Ceiling mounted fixed panel

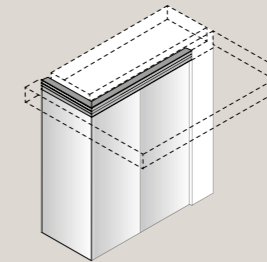

Pannello fisso ad incasso / Recessed fixed panel

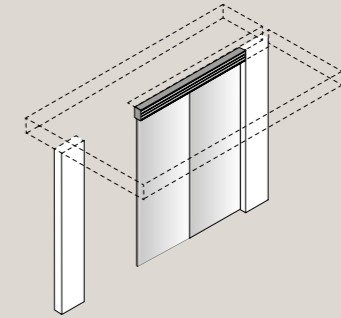

### Pannelli fissi divisori / Fixed panels dividers

Pannello fisso divisorio / Fixed panel divider

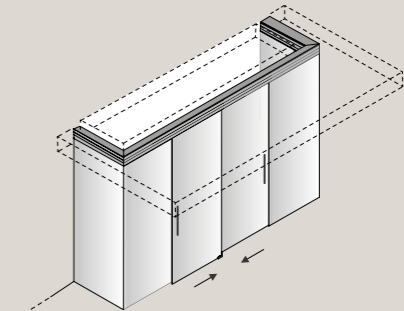

2 pannelli fissi e 2 ante su binario birotaia a soffitto / 2 fixed panels and 2 doors on recessed double track

## Vista by CRS Pianca

# Vista Crystal

**Dimensioni / Dimensions**

L da 70 a 120 cm  
H da 190 a 280 cm

W from 27.56" to 47.24"  
H from 74.80" to 110.24"

Pannello fisso,  
L da 70 a 120 cm  
H da 190 a 280 cm

*Fixed panel*  
W from 27.56" to 47.24"  
H from 74.80" to 110.24"

Binario di scorrimento,  
L max 600 cm

*Track*  
W max 236.22"

**Maniglie / Handles**

Con Gola U40  
With groove U40

**Finiture / Finishes**

*Finiture anta*  
Vetro

*Door finishes*  
Glass

*Finiture Binario*  
Alluminio Anodizzato o pitturabile  
con tempere murarie

*Track Finishes*  
Anodised or paintable aluminum

*Finiture maniglia*

Metallo  
Laccato Opaco  
*Handles finishes*  
Metal  
Matt Lacquered

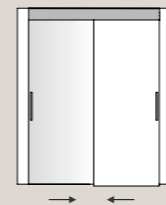
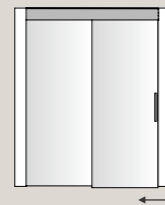
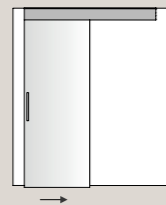
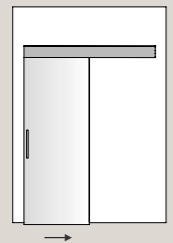

Anta scorrevole  
con binario a parete /  
Sliding door with wall  
mounted track

Anta scorrevole  
con binario a soffitto /  
Sliding door with ceiling  
mounted track

Anta scorrevole e  
pannello fisso con binario  
a soffitto / Door and fixed  
panel on ceiling mounted  
track

2 ante scorrevoli  
con binario a soffitto /  
2 sliding doors with  
ceiling mounted track

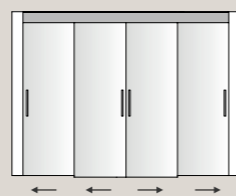
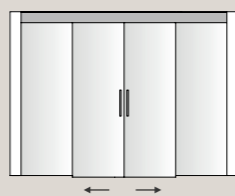
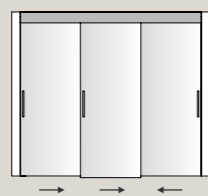
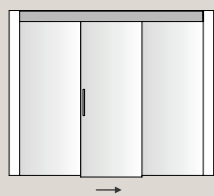

Anta scorrevole e 2  
pannelli fissi binario  
a soffitto / Door and 2  
fixed panels on a ceiling  
mounted track

3 ante scorrevoli  
con binario a soffitto /  
3 sliding doors with  
ceiling mounted track

2 ante scorrevoli  
e 2 pannelli fissi binario  
a soffitto / 2 sliding doors  
and 2 fixed panels on  
a ceiling mounted track

4 ante scorrevoli binario  
a soffitto / 4 sliding doors  
on a ceiling mounted  
track

# Vista Plana

**Dimensioni / Dimensions**

L da 70 a 120 cm  
H da 190 a 280 cm

W from 27.56" to 47.24"  
H from 74.80" to 110.24"

Pannello fisso,  
L da 70 a 120 cm  
H da 190 a 280 cm

*Fixed panel*  
W from 27.56" to 47.24"  
H from 74.80" to 110.24"

Binario di scorrimento,  
L max 600 cm

*Track*  
W max 236.22"

**Maniglie / Handles**

U40

**Finiture / Finishes**

*Finiture anta*  
Laccato Opaco o Lucido, Essenza,  
Materico, Pitturabile con tempere  
murarie

*Door finishes*  
Matt or High Gloss Lacquered, Wood,  
Materico, Paintable

*Finiture Binario*  
Alluminio Anodizzato o pitturabile  
con tempere murarie

*Track Finishes*  
Anodised or paintable aluminum

*Finiture maniglia*  
Metallo, Laccato Opaco

*Handles finishes*  
Metal, Matt Lacquered

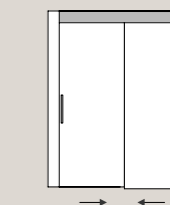
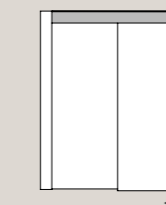
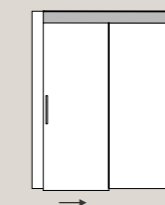
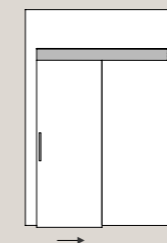

Anta scorrevole  
con binario a parete /  
Sliding door with wall  
mounted track

Anta scorrevole  
con binario a soffitto /  
Sliding door with ceiling  
mounted track

Anta scorrevole e  
pannello fisso con binario  
a soffitto / Door and fixed  
panel on ceiling mounted  
track

2 ante scorrevoli  
con binario a soffitto /  
2 sliding doors with  
ceiling mounted track

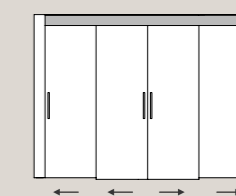
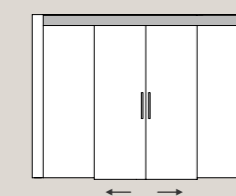
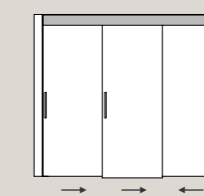
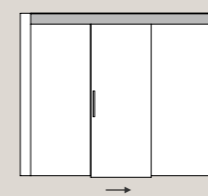

Anta scorrevole e 2  
pannelli fissi binario  
a soffitto / Door and 2  
fixed panels on a ceiling  
mounted track

3 ante scorrevoli  
con binario a soffitto /  
3 sliding doors with  
ceiling mounted track

2 ante scorrevoli  
e 2 pannelli fissi binario  
a soffitto / 2 sliding doors  
and 2 fixed panels on  
a ceiling mounted track

4 ante scorrevoli binario  
a soffitto / 4 sliding doors  
on a ceiling mounted  
track

**Pianca S.p.A**  
Via dei Cappellari, 20  
31018 – Gaiarine, Treviso  
Italy

T +39 0434 756911  
F +39 0434 75330

info@pianca.com  
pianca.com

p. iva IT01682580269

**Art direction**

Roberto Barazzuol

**Graphic design**

72STEPS.atelier

**Styling**

Stanza [97.] di Elena Caponi e Paola Craca

**Photography**

Photografica Studio

**Rendering and matching**

Nudesign

**Printed**

Grafiche Antiga

Vietata la riproduzione a qualsiasi scopo.  
Campione promozionale gratuito non destinato alla vendita.  
Escluso iva art.2 comma 3D.P.R. 633/72  
Esonerato da documento di trasporto art.4 punto 6 d.p.r.627/78

Reproduction prohibited for any purpose.  
Free promotional sample not for sale.  
Excluding VAT Article 2 paragraph 3D.P.R. 633/72  
Exempted from transport document art.4 point 6 d.p.r.627/78

© Pianca 2023

Pianca azienda  
certificata FSC®



Il marchio della  
gestione forestale  
responsabile

Chiedi i prodotti  
certificati FSC®

